

OPERATION AND SERVICE MANUAL

HYAMP® III

MODEL 3130 GROUND BOND TESTER

SERIAL NUMBER

--	--	--	--	--	--	--

Model 3130

Item 38301

Ver 1.12

© Associated Research, Inc., 2010
13860 West Laurel Drive
Lake Forest, Illinois 60045-4546
U.S.A.

Printed January 15, 2010



DECLARATION OF CONFORMITY

Manufacturer: Associated Research, Inc.
Address: 13860 W. Laurel Dr.
Lake Forest, IL 60045
USA
Product Name: HYAMP[®] III Ground Bond Tester
Model Number: 3130

Conforms to the following Standards:

Safety: IEC 61010-1: 1993 + A2

EMC: EN 55011: 1998 Group I Class A,
EN 61326: 1997 + A1: 1998,
(EN 61000-4-2: 1995, EN 61000-4-3: 1996,
EN 61000-4-4: 1995, EN 61000-4-5: 1995,
EN 61000-4-6: 1996, EN 61000-4-8: 1993,
EN 61000-4-11: 1994)

Supplementary Information

*The product herewith complies with the requirements of the **Low Voltage Directive 73/23/EEC as amended by 93/68/EEC** and the **EMC Directive 89/336/EEC as amended by 92/31/EEC**.*

The CE marking has been affixed on the device according to article 10 of the EMC Directive 8/336/EEC.

The technical file and other documentation are on file with Associated Research, Inc.

Joseph Guerriero
Vice President / General Manager

Associated Research, Inc.
Lake Forest, Illinois USA
April 3, 2002

TABLE OF CONTENTS

1. Introduction.....	1
1.1. Warranty.....	1
1.2. Safety Symbols	2
1.2.1. Product Marking Symbols	2
1.2.2. Caution and Warning Symbols	2
1.3. Glossary of Terms.....	3
1.4. Safety	4
1.4.1. Service and Maintenance	4
1.4.2. Test Station	5
1.4.3. Test Operator.....	6
1.5. Introduction to Product Safety Testing	7
1.5.1. The Importance of Safety Testing	7
1.6. The Different Types of Safety Tests.....	7
1.6.1. Principles and Uses of Dielectric Withstand Testing	7
1.6.2. Insulation Resistance Test	10
1.6.3. Ground Bond Test	10
1.6.4. Run Test.....	11
1.6.5. Line Leakage Test	11
1.7. Key Features and Benefits.....	13
2. Getting Started	15
2.1. Unpacking and Inspection	15
2.1.1. Packaging.....	15
2.1.2. Contents of Carton.....	15
2.1.3. Returning the Instrument for Service or Calibration.....	15
2.2. Installation	16
2.2.1. Work Area.....	16
2.2.2. Power Requirements.....	16
2.2.3. Basic Connections	16
2.2.4. Environmental Conditions	17
3. Specifications and Controls.....	18
3.1. Specifications.....	18
3.2. Instrument Controls	20
3.2.1. Front Panel Controls	20
3.2.2. Rear Panel Controls.....	21
3.3. Quickstart	22
4. Programming Instructions.....	25
4.1. Setup System	25
4.1.1. Cal Alert (Calibration Alert).....	29
4.2. Setting up Tests.....	32

4.2.1. Reviewing Test parameters.....	32
4.2.2. Editing Test Parameters.....	33
4.2.3. Reviewing Test Results	33
4.3. Test Parameters.....	33
4.3.1. Ground Bond Test Parameters	34
4.3.2. Default Parameters	35
5. Operating Instructions	36
5.1. Instrument Connections	36
5.1.1. Adapter Box Connections (Adapter box is sold separately).....	36
5.2. Perform Tests, Main Menu, and Results Screens	37
5.2.1. Connected Step Indicator.....	37
5.2.2. Main Menu.....	37
5.3. Perform Tests Metering.....	40
5.4. Performing a Test.....	40
6. Instrument Verification.....	42
6.1. Verification Initialization	42
6.2. Verification Menu.....	42
6.2.1. Ground Bond Verification	43
7. Remote Control	44
7.1. Signal Outputs on Remote I/O.....	44
7.2. Signal Inputs of Remote I/O and Memory Access	46
7.3. System 3100, HYAMP III Integrated with HYPOT III.....	48
8. Options.....	50
9. Calibration Procedure.....	57
9.1. Warranty Requirements	57
9.2. Calibration Initialization	58
9.2.1. Calibration of Parameters	58
10. Replacement Parts List	60
11. Schematic Index.....	61

Index is located at the back of the Manual.

1. Introduction

1.1. 5 Year Warranty Policy

Associated Research, Inc., certifies that the instrument listed in this manual meets or exceeds published manufacturing specifications. This instrument was calibrated using standards that are traceable to the National Institute of Standards and Technology (NIST).

Your new instrument is warranted to be free from defects in workmanship and material for a period of (1) year from date of shipment. You must return the “Owners Registration Card” provided within (15) days from receipt of your instrument.

AR recommends that your instrument be calibrated on a twelve-month cycle. Instruments purchased and used in North America only, may have their warranty extended in one year increments to a maximum of **(5) years** provided they are returned to AR at least **annually** for calibration and inspection. The annual calibration and inspection must be performed annually every year following receipt of instrument. Any instrument not calibrated and inspected annually will not be eligible for extended warranty status. This extended warranty is non-transferable and is offered only to the original purchaser. A return material authorization (RMA) must be obtained from AR before returning this instrument for warranty service. Please contact our Customer Support Center at 1-800-858-TEST (8378) to obtain an RMA number. It is important that the instrument is packed in its original container for safe transport. If the original container is not available please contact our customer support center for proper instructions on packaging. Damages sustained as a result of improper packaging will not be honored. Transportation costs for the return of the instrument for warranty service must be prepaid by the customer. AR will assume the return freight costs when returning the instrument to the customer. The return method will be at the discretion of Associated Research.

Except as provided herein, Associated Research makes no warranties to the purchaser of this instrument and all other warranties, express or implied (including, without limitation, merchantability or fitness for a particular purpose) are hereby excluded, disclaimed and waived.

Any non-authorized modifications, tampering or physical damage will void your warranty. Elimination of any connections in the earth grounding system or bypassing any safety systems will void this warranty. This warranty does not cover batteries or accessories not of Associated Research manufacture. Parts used must be parts that are recommended by AR as an acceptable specified part. Use of non-authorized parts in the repair of this instrument will void the warranty.

1.2. Safety Symbols

1.2.1. Product Marking Symbols



Product will be marked with this symbol when it is necessary to refer to the operation and service manual in order to prevent injury or equipment damage.



Product will be marked with this symbol when hazardous voltages may be present.



Product will be marked with this symbol at connections that require earth grounding.

1.2.2. Caution and Warning Symbols

WARNING

Calls attention to a procedure, practice, or condition that could possibly cause bodily injury or death.

CAUTION

Calls attention to a procedure, practice, or condition that could possibly cause damage to equipment or permanent loss of data.

1.3. Glossary of Terms

(As used in this manual)

Alternating Current, AC: Current that reverses direction on a regular basis, commonly in the U.S.A. 60 per second, in other countries 50 times per second.

Conductive: Having a volume resistivity of no more than 10^3 ohm-cm or a surface resistivity of no more than 10^5 ohms per square.

Conductor: A solid or liquid material which has the ability to let current pass through it, and which has a volume resistivity of no more than 10^3 ohm-cm.

Current: The movement of electrons through a conductor. Current is measured in amperes, milliamperes, microamperes, nanoamperes, or picoamperes. Symbol = **I**

Dielectric: An insulating material that is positioned between two conductive materials in such a way that a charge or voltage may appear across the two conductive materials.

Direct Current, DC: Current that flows in one direction only. The source of direct current is said to be polarized and has one terminal that is always at a higher potential than the other.

Hipot Tester: Common term for dielectric-withstand test equipment.

HYAMP®: Registered trademark of Associated Research, Inc., for its Ground Bond test equipment.

HYPOT®: Registered trademark of Associated Research, Inc., for its dielectric-withstand test equipment.

Insulation: Gas, liquid or solid material which has a volume resistivity of at least 10^{12} ohm-cm and is used for the purpose of resisting current flow between conductors.

Resistance: That property of a substance that impedes current and results in the dissipation of power, in the form of heat. The practical unit of resistance is the *Ohm*. Symbol = **R**

Trip Point: A minimum or maximum parameter set point that will cause an indication of unacceptable performance during a run test.

Voltage: Electrical pressure, the force which causes current through an electrical conductor. Symbol = **V**

1.4. Safety

This product and its related documentation must be reviewed for familiarization with safety markings and instructions before operation.

This product is a Safety Class I instrument (provided with a protective earth terminal). Before applying power verify that the instrument is set to the correct line voltage (115 or 230) and the correct fuse is installed.

1.4.1. Service and Maintenance

User Service

To prevent electric shock do not remove the instrument cover. There are no user serviceable parts inside. Routine maintenance or cleaning of internal parts is not necessary. Avoid the use of cleaning agents or chemicals on the instrument, some chemicals may damage plastic parts or lettering. Any external cleaning should be done with a clean dry or slightly damp cloth. Schematics, when provided, are for reference only. Any replacement cables and high voltage components should be acquired directly from Associated Research, Inc. Refer servicing to an Associated Research, Inc. authorized service center.

ASSOCIATED RESEARCH, INC.
13860 WEST LAUREL DRIVE
LAKE FOREST, IL 60045-4546 U.S.A.

(PHONE: 1 (847) 367-4077
1 (800) 858-TEST (8378)
FAX: 1 (847) 367-4080
E-MAIL : info@asresearch.com
www.asresearch.com

Service Interval

The instrument, its power cord, test leads, and accessories must be returned at least once a year to an Associated Research authorized service center for calibration and inspection of safety related components. Associated Research will not be held liable for injuries suffered if the instrument is not properly maintained and safety checked annually.

User Modifications

Unauthorized user modifications will void your warranty. Associated Research will not be responsible for any injuries sustained due to unauthorized equipment modifications or use of parts not specified by Associated Research. Instruments returned to Associated Research with unsafe modifications will be returned to their original operating condition at the customers expense.

1.4.2. Test Station

Location

Select an area away from the main stream of activity which employees do not walk through in performing their normal duties. If this is not practical because of production line flow, then the area should be roped off and marked for **TESTING**. No employees other than the test operators should be allowed inside.

If benches are placed back-to-back, be especially careful about the use of the bench opposite the test station. Signs should be posted: "**DANGER - TEST IN PROGRESS - UNAUTHORIZED PERSONNEL KEEP AWAY.**"

Work Area

Perform the tests on a non-conducting table or workbench, if possible. There should not be any metal in the work area between the operator and the location where products being tested will be positioned.

Position the tester so the operator does not have to reach over the product under test to activate or adjust the tester. If the product or component being tested is small, it may be possible to construct guards or an enclosure around the device to be tested. Construct the guards of a non-conducting material such as clear acrylic, so that the item being tested is within the guards or enclosure during the test. If possible, the guards or enclosure should also contain safety switches that will not allow the tester to operate unless the guards are in place or the enclosure closed.

Keep the area clean and uncluttered. All test equipment and test leads not necessary for the test should be removed from the test bench and put away. It should be apparent to both the operator and to any observers, the product that is being tested and the product that is waiting to be tested, or has already been tested.

Do not perform Ground Bond tests in a combustible atmosphere or in any area where combustible materials are present.

Power

Be certain that the power wiring to the test bench is properly polarized and that the proper low resistance bonding to ground is in place.

Power to the test station should be arranged so that it can be shut off by one prominently marked switch located at the entrance to the test area. In case of an emergency, anyone can cut off the power before entering the test area to offer assistance.

1.4.3. Test Operator

Qualifications

The operator should understand the electrical fundamentals of voltage, current, and resistance.

Rules

Operators should be thoroughly trained to follow all of the aforementioned rules, in addition to any other applicable safety rules and procedures. Defeating any safety system should be considered a serious offense with severe penalties such as removal from the Ground Bond testing job. Allowing unauthorized personnel in the area during a test should also be dealt with as a serious offense.

Dress

Operators should not wear jewelry that could accidentally complete a circuit.

Medical Restrictions

Personnel with heart ailments or devices such as pacemakers should be informed that the current generated by the instrument are very dangerous. If contacted it may cause heart-related problems that a person of good health may not experience. Please have the test operator consult their physician for recommendations.

1.5. Introduction to Product Safety Testing

1.5.1. The Importance of Safety Testing

Product Safety Tests are specified during the design and development stages of a product as well as in the production of the products to insure that it meets basic safety requirements. These tests are designed to verify the safety of the electrical products in that they do not jeopardize the safety of the people, domestic animals, and property of anyone who may come in contact with these products. In an era of soaring liability costs, original manufacturers of electrical and electronic products must make sure every item is as safe as possible. All products must be designed and built to prevent electric shock, even when users abuse the equipment or by-pass built in safety features.

To meet recognized safety standards, one common test is the "dielectric voltage-withstand test". Safety agencies which require compliance safety testing at both the initial product design stage and for routine production line testing include: Underwriters Laboratories, Inc. (UL), the Canadian Standards Association (CSA), the International Electrotechnical Commission (IEC), the British Standards Institution (BSI), the Association of German Electrical Engineers (VDE) and (TÜV), the Japanese Standards Association (JSI). These same agencies may also require that an insulation resistance test and high current ground bond test be performed.

1.6. The Different Types of Safety Tests

1.6.1. Dielectric Withstand Test

The principle behind a dielectric voltage - withstand test is simple. If a product will function when exposed to extremely adverse conditions, it can be assumed that the product will function in normal operating circumstances.

Common Applications of the Dielectric Withstand Test:

- Design (performance) testing: Determining design adequacy to meet service conditions.
- Production Line testing: Detecting defects in material or workmanship during processing.
- Acceptance testing: Proving minimum insulation requirements of purchased parts.
- Repair Service testing: Determine reliability and safety of equipment repairs.

The specific technique used to apply the dielectric voltage - withstand test to each product is different. During a dielectric voltage - withstand test, an electrical device is exposed to a voltage significantly higher than it normally encounters, for a specified duration of time.

During the test, all current flow from the high voltage output to the return is measured. If, during the time the component is tested, the current flow remains within specified limits, the device is assumed safe under normal conditions. The basic product design and use of the insulating material will protect the user against electrical shock.

The equipment used for this test, a dielectric-withstand tester, is often called a "hipot" (for high potential tester). The "rule of thumb" for testing is to subject the product to twice its normal operating voltage, plus 1,000 volts.

However, specific products may be tested at much higher voltages than 2X operating voltages + 1,000 volts. For example, a product designed to operate in the range between 100 to 240 volts can be tested between 1,000 to 4,000 volts or higher. Most "double insulated" products are tested at voltages much higher than the "rule of thumb".

Testing during development and prototype stages is more stringent than production run tests because the basic design of the product is being evaluated. Design tests usually are performed on only a few samples of the product. Production tests are performed on every item as it comes off the production line.

The hipot tester must also maintain an output voltage between 100% and 120% of specification. The output voltage of the hipot must have a sinusoidal waveform with a frequency between 40 to 70 Hz and has a peak waveform value that is not less than 1.3 and not more than 1.5 times the root-mean-square value.

Types of Failures only detectable with a Hipot test

- Weak Insulating Materials
- Pinholes in Insulation
- Inadequate Spacing of Components
- Pinched Insulation

Dielectric Withstand Test; AC versus DC

Please check with the Compliance Agency you are working with to see which of the two types of voltages you are authorized to use. In some cases, a Compliance Agency will allow either AC or DC testing to be done. However, in other cases the Compliance Agency only allows for an AC test. If you are unsure which specification you must comply with please contact our CUSTOMER SUPPORT GROUP at 1-800-858-TEST (8378).

Many safety agency specifications allow either AC or DC voltages to be used during the hipot test. When this is the case, the manufacturer must make the decision on which type of voltage to utilize. In order to do this it is important to understand the advantages and the disadvantages of both AC and DC testing.

AC testing characteristics

Most items that are hipot tested have some amount of distributed capacitance. An AC voltage cannot charge this capacitance so it continually reads the reactive current that flows when AC is applied to a capacitive load.

AC testing advantages

AC testing is generally much more accepted by safety agencies than DC testing. The main reason for this is that most items being hipot tested will operate on AC voltages. AC hipot testing offers the advantage of stressing the insulation alternately in both polarities, which more closely simulates stresses the product will see in real use.

Since AC testing cannot charge a capacitive load the current reading remains consistent from initial application of the voltage to the end of the test. Therefore, there is no need to gradually bring up the voltage since there is no stabilization required to monitor the current reading. This means that unless the product is sensitive to a sudden application of voltage the operator can immediately apply full voltage and read current without any wait time.

Another advantage of AC testing is that since AC voltage cannot charge a load there is no need to discharge the item under test after the test.

AC testing disadvantages

One disadvantage of AC testing surfaces when testing capacitive products. Again, since AC cannot charge the item under test, reactive current is constantly flowing. In many cases, the reactive component of the current can be much greater than the real component due to actual leakage. This can make it very difficult to detect products that have excessively high leakage current.

Another disadvantage of AC testing is that the hipot has to have the capability of supplying reactive and leakage current continuously. This may require a current output that is actually much higher than is really required to monitor leakage current and in most cases is usually much higher than would be needed with DC testing. This can present increased safety risks as operators are exposed to higher currents.

DC testing characteristics

During DC hipot testing the item under test is charged. The same test item capacitance that causes reactive current in AC testing results in initial charging current which exponentially drops to zero in DC testing.

DC testing advantages

Once the item under test is fully charged, the only current flowing is true leakage current. This allows a DC hipot tester to clearly display only the true leakage of the product under test.

Another advantage to DC testing is that the charging current only needs to be applied momentarily. This means that the output power requirements of the DC hipot tester can typically be much less than what would be required in an AC tester to test the same product.

DC testing disadvantages

Unless the item being tested has virtually no capacitance, it is necessary to raise the voltage gradually from zero to the full test voltage. The more capacitive the item the more slowly the voltage must be raised. This is important since most DC hipots have failure shut off circuitry

which will indicate failure almost immediately if the total current reaches the leakage threshold during the initial charging of the product under test.

Since a DC hipot does charge the item under test, it becomes necessary to discharge the item after the test.

DC testing unlike AC testing only charges the insulation in one polarity. This becomes a concern when testing products that will actually be used at AC voltages. This is an important reason that some safety agencies do not accept DC testing as an alternative to AC.

When performing AC hipot tests the product under test is actually tested with peak voltages that the hipot meter does not display. This is not the case with DC testing since a sinewave is not generated when testing with direct current. In order to compensate for this most safety agencies require that the equivalent DC test be performed at higher voltages than the AC test. The multiplying factor is somewhat inconsistent between agencies which can cause confusion concerning exactly what equivalent DC test voltage is appropriate.

1.6.2. Insulation Resistance Test

Some "dielectric analyzers today come with a built in insulation resistance tester. Typically, the IR function provides test voltages from 500 to 1,000 volts DC and resistance ranges from kilohms to gigaohms. This function allows manufacturers to comply with special compliance regulations. BABT, TÜV and VDE are agencies that may under certain conditions, require an IR test on the product before a Hipot test is performed. This typically is not a production line test but a performance design test.

The insulation resistance test is very similar to the hipot test. Instead of the go/no go indication that you get with a hipot test the IR test gives you an insulation value usually in Megohms. Typically, the higher the insulation resistance value the better the condition of the insulation. The connections to perform the IR test are the same as the hipot test. The measured value represents the equivalent resistance of all the insulation which exists between the two points and any component resistance which might also be connected between the two points.

Although the IR test can be a predictor of insulation condition it does not replace the need to perform a dielectric withstand test.

1.6.3. Ground Bond Test

The Ground Bonding test determines whether the safety ground circuit of the product under test can adequately handle fault current if the product should ever become defective. A low impedance ground system is critical in ensuring that in case of a product failure, a circuit breaker on the input line will act quickly to protect the user from any serious electrical shock.

International compliance agencies such as CSA, IEC, TÜV, VDE, BABT and others, have requirements calling out this test. This test should not be confused with low current continuity tests that are also commonly called out in some safety agency specifications. A low current test merely indicates that there is a safety ground connection. It does not completely test the integrity of that connection.

Compliance agency requirements vary on how different products are to be tested. Most specifications call for test currents of between 10 and 30 amps. Test voltages at these currents are typically required to be less than 12 volts. Maximum allowable resistance readings of the safety ground circuit are normally between 100 and 200 milliohms.

If you are testing a product that is terminated in a three-prong plug, you are required to perform a continuity or ground bond test on the ground conductor to the chassis or dead metal of the product.

1.6.4. Run Test

All manufacturers of a product that runs on line power normally need to run the DUT (Device Under Test) after final safety testing so that they can verify the functionality of their products. In addition to running the DUT to test its basic functionality many customers also require some basic test data to be recorded while the DUT is powered up. A Run Test System allows the product to be powered up immediately after the safety tests are completed with a single connection to the DUT. Measurements that are commonly made while the DUT is running can include Amperage, Voltage, Watts and Power Factor.

1.6.5. Line Leakage Test

The Line Leakage test is one of many product safety tests that are normally specified for electrical products by safety testing agencies such as Underwriters Laboratories (UL) and the International Electrotechnical Committee (IEC). The line leakage specifications vary as well as the method in which the measurements are taken depending upon the application or function of a product and the standard to which the product is being tested.

Current Leakage or Line Leakage tests are general terms that actually describe three different types of tests. These tests are Earth Leakage Current, Enclosure Leakage Current, and Applied Part Leakage Current. The main differences in these tests are in the placement of the probe for the measuring device. The Earth Leakage Current is the leakage current that flows through the ground conductor in the line cord back to earth. The Enclosure Leakage Current is the current that flows from any enclosure part through a person back to ground if it were contacted by a person. The Applied Part Leakage Current or Patient Lead Leakage Current is any leakage that flows from an applied part, between applied parts or into an applied part. The Applied Part Leakage Current test is required only for medical equipment. All of these tests are used to determine if products can be safely operated or handled without posing a shock hazard to the user.

Line Leakage Testers provide the capability of meeting the line leakage test specified in the following standards; UL 544, IEC 950, UL 1950, IEC 601-1, UL 2601, UL 1563, UL 3101, IEC 1010 and others. The Line Leakage test, is a test which measures the leakage current of a product, through a circuit that is designed to simulate the impedance of the human body. The simulation circuit is called the Measuring Device (MD). The instrument has five different MD circuits, selectable through the menu, which are representative circuits designed to simulate the impedance of the human body under different conditions. The impedance of the human body will vary depending upon point of contact, the surface area of the contact and the path the current flows. For these reasons, the specifications of the Measuring Devices are different depending upon the type of test being performed as well as the maximum allowable leakage

current. Leakage current measurements are performed on products under normal conditions and single fault conditions as well as reversed polarity. This simulates possible problems, which could occur if the product under test is faulted or misused while the product is operating under high line conditions (110% of the highest input voltage rating of the product).

Line Leakage tests are normally specified as “Type Tests” or “Design Tests” which are performed during the development of the product. This helps verify that the design is safe but it does not guarantee the safety of the products being produced on the production line. The only way to be sure you are shipping safe products is to test each product at the end of the production line. The user may perform a Leakage Current test along with other common safety test such as Dielectric Withstand, Insulation Resistance, and Ground Bond on the production line with a single connection to the device under test.

IF YOU SHOULD HAVE ANY QUESTIONS RELATING TO THE OPERATION OF YOUR INSTRUMENT CALL 1-800-858-TEST(8378) IN THE U.S.A.

Key Features and Benefits: HYAMP III

The first manual Ground Bond instrument with an enhanced graphic LCD	<p>This provides the operator with complete test setup and results in an easy-to-use interface. This eliminates the need to decipher cryptic abbreviations. The graphic display makes testing safer, easier and more reliable than ever before.</p>
All parameters for the setups can be adjusted through a simple menu driven program by using front panel keys	<p>The easy to follow setup screens ensure that the operator correctly sets up all test parameters.</p>
Tamper proof front panel controls	<p>This makes it possible to limit user access to the setup screens so that only authorized personnel with a security code can change test parameters.</p>
Storage of up to 10 different test programs	<p>A real benefit for manufacturers that test different products. This makes it possible to store all the various test parameters required and quickly recall them for each of the different products that needs to be tested. Memories can also be linked to run multi step tests.</p>
Interconnection with HYPOT III	<p>Interconnection of the HYAMP III and the HYPOT III makes these two instruments a complete test system. The test system can be configured to test Ground Bond first and then advance to the Dielectric Withstand test and Insulation Resistance tests. The test system can also be configured to perform Ground Bond and Dielectric Withstand tests simultaneously.</p>
Line and Load regulation	<p>This system maintains the output current to within 2% from no load to full load and over the line voltage range to ensure that test results remain consistent and within safety agency requirements.</p>
User selectable output voltage frequencies of 50 or 60 Hertz	<p>HYAMP III was designed for the global market. This feature makes it simple for the user to select the output frequency in the Ground Bond mode so that products can be tested at the same frequency they will be used at.</p>
Adjustable output current and milliohm trip ranges	<p>This capability makes the HYAMP III versatile enough to meet all safety agency specifications for ground bond test requirements.</p>
Four wire measurement (Kelvin method) and milliohm offset capability	<p>These features minimize the effect of test lead resistance. The four wire measurement technique eliminates test lead resistance when using the standard test leads. The milliohm offset function allows the use of longer test leads and test fixtures without compromising the test results.</p>

PLC remote inputs and outputs	The standard 9 pin interfaces provide outputs for Pass, Fail, Test in Process, Start Out, and Reset Out. Inputs include Test, Reset, Interlock, and Withstand Processing. Remote recall of memory program #1, #2 and #3. This gives the user all the basic remotes required to configure the Hypot III through simple PLC relay control.
Test indicator	A flashing LED clearly indicates when high current is active to provide maximum operator safety.
Withstand processing indicator	The enhanced graphic LCD indicates when the high voltage from the HYPOT III is being applied to the item under test for greater operator safety.
Software calibration control	HYAMP III is calibrated through the front panel keypad. All calibration information is stored in non-volatile memory. This allows HYAMP III to be completely calibrated without removing any covers and exposing the technician to hazardous voltages.
No load setup of output current	This provides the operator with an easy and safe way to set output current since parameters are set without the current output activated.
TUV & UL listing	This assures you that this instrument meets or exceeds safety requirements to ensure operator safety.
Automatic storage of test program	HYAMP III powers up with the parameters that were used during the last test to avoid operator setup errors.
Electronic dwell settings	The electronic dwell control helps keep test results consistent by ensuring that the test duration is the same for each product tested.
Low-current sense	Monitors the minimum level of current flow, thus ensuring that the DUT is properly connected and that the hipot test is being performed.
User selectable input voltage	HYAMP III can be switched for either 115 or 230 volt input operation through an easy access rear panel mounted switch to allow it to be used in any country.

2. Getting Started

Introduction

This section contains information for the unpacking, inspection, preparation for use and storage of your Associated Research, Inc., product.

2.1. Unpacking and Inspection

2.1.1. Packaging

Your instrument was shipped in a custom foam insulated container that complies with ASTM D4169-92a Assurance Level II Distribution Cycle 13 Performance Test Sequence.

If the shipping carton is damaged, inspect the contents for visible damage such as dents, scratches or broken display. If the instrument is damaged, notify the carrier and Associated Research's customer support department. Please save the shipping carton and packing material for the carriers inspection. Our customer support department will assist you in the repair or replacement of your instrument. Please do not return your product without first notifying us and receiving an RMA (return material authorization) number. To receive an RMA number, please contact our customer support department at (1-800-858-8378).

- Please retain all of the original packaging materials.

2.1.2. Contents of the Carton

Inside the carton should be the following:

Description	AR Part Number
HYAMP III Instrument	3130
Cable ASSY High Current Output	05002D-24
Cable ASSY High Current Return	05002D-37
Fuse	37780, 6.3 Amp, slow-blow 250VAC
Line Cord*	33189 Standard
Interlock Connector	38075

2.1.3. Returning the Instrument

When it is necessary to return the instrument for servicing or calibration, repackage the instrument in its original container, please include all accessories and test leads. Indicate the nature of the problem or type of service needed. Also, please mark the container "FRAGILE" to insure proper handling. Upon receipt, your instrument will be issued an AR service number. Please refer to this number in all correspondence.

If you do not have the original packaging materials, please follow these guidelines:

- Wrap the instrument in a bubble pack or similar foam. Enclose the same information as above.

- Use a strong double-wall container that is made for shipping instrumentation. 350-lb. test material is adequate.
- Use a layer of shock-absorbing material 70 to 100 mm (3 to 4 inch) thick around all sides of the instrument. Protect the control panel with cardboard.
- Seal the container securely.
- Mark the container "FRAGILE" to insure proper handling.
- Please refer in all correspondence to your AR service number.

2.2. Installation

2.2.1. Work Area

WARNING Locate a suitable testing area and be sure you have read all safety instructions for the operation of the instrument and suggestions on the test area set-up in the Safety section. Make sure the work area you choose has a three-prong grounded outlet. Be sure the outlet has been tested for proper wiring before connecting the instrument to it.

2.2.2. Power Requirements

This instrument requires a power source of either 115 volts AC \pm 10%, 50/60 Hz single phase or 230 volts AC \pm 10%, 50/60 Hz single phase. Please check the rear panel to be sure the proper switch setting is selected for your line voltage requirements before turning your instrument on. For operation at 115 and 230 Volts AC use a 6.3 Amp, slow-blow 250VAC fuse.

CAUTION Do not switch the line voltage selector switch located on the rear panel while the instrument is on or operating. This may cause internal damage and represents a safety risk to the operator.

2.2.3. Basic Connections

Power Cable

WARNING Before connecting power to this instrument, the protective ground (Earth) terminals of this instrument must be connected to the protective conductor of the line (mains) power cord. The main plug shall only be inserted in a socket outlet (receptacle) provided with a protective ground (earth) contact. This protective ground (earth) **must not be defeated** by the use of an extension cord without a protective conductor (grounding).

The instrument is shipped with a three-wire power cable. When the cable is connected to an appropriate AC power source, the cable will connect the chassis to earth ground. The type of power cable shipped with each instrument depends on the country of destination.

Test Leads

The test leads provided are designed specifically for use with this instrument. The red Cable ASSY High Current Output will mate with the red Current jack. The black Cable ASSY High Current Return will install into the black Return jack.

The test lead ratings are as follows:

Description	Part Number	Rating
Cable ASSY High Current Output	05002D-24	31 A, 750V
Cable ASSY High Current Return	05002D-37	31 A, 750V

2.2.4. Environmental Conditions

This equipment is intended for indoor use only. The equipment has been evaluated according to Installation Category II and Pollution Degree 2 as specified in IEC 664.

This instrument may be operated in environments with the following limits:

Temperature.....32° - 104° F (0° - 40° C)

Relative humidity0 - 80%

Altitude6,560 feet (2,000 meters)

Storage and Shipping Environment

This instrument may be stored or shipped in environments with the following limits:

Temperature..... -40° - 167° F (-40° - 75°C)

Altitude..... 50,000 feet (15,240 meters)

The instrument should also be protected against temperature extremes that may cause condensation within the instrument.

3. Specifications and Controls

3.1. HYAMP III Functional Specifications

INPUT	
Voltage	115/230 VAC \pm 10%, user selectable
Frequency	50/60 Hz \pm 5%
Fuse	6.3 Amp, slow-blow 250 VAC
TEST MODE	
Output Rating	Current: 1.00 – 30.00 Amps AC Resolution: 0.01 Amp/step Regulation: \pm (2% of setting + 0.02 Amps) Voltage: 6 Volts AC, fixed
Output Frequency	Range: 50 / 60 Hz, user selectable
Dwell Time Setting	Range: 0 and 0.5 – 999.9 seconds, 0 for continuous running Resolution: 0.1 second/step Accuracy: \pm (0.1% of setting + 0.05 seconds)
Maximum Limit	Range: 0 – 120 m Ω for 1 – 30 Amps 0 – 510 m Ω for 1 – 10 Amps Resolution: 1 m Ω /step Accuracy: \pm (2% of setting + 2 m Ω)
Minimum Limit	Range: 0 – 120 m Ω for 1 – 30 Amps 0 – 510 m Ω for 1 – 10 Amps Resolution: 1 m Ω /step Accuracy: \pm (2% of setting + 2 m Ω)
Offset Capability	Range: 0 – 100 m Ω Resolution: 1 m Ω /step Accuracy: \pm (2% of setting + 2 m Ω)
Current Display	Range: 0.00 – 30.00 Amps Resolution: 0.01 Amp/step Accuracy: \pm (3% of reading + 0.03 Amps)
Ohmmeter Display	Range: 0 – 510 m Ω Resolution: 1 m Ω /step Accuracy: \pm (2% of reading + 2 m Ω)
Timer Display	Range: 0.0 – 999.9 seconds Resolution: 0.1 seconds/step Accuracy: \pm (0.1% of reading + 0.05 seconds)

GENERAL	
Remote Control And Signal Output	The following input and output signals are provided through two 9 pin D type connectors; <ol style="list-style-type: none"> 1. Remote control: Test, Reset, Interlock, and Withstand Processing. 2. Remote recall of memory program #1, #2 and #3. 3. Outputs: Pass, Fail, Test-in-Process, Start Out, and Reset Out.
Program Memory	10 Memories, 3 steps per memory, all steps within a memory are linkable.
Security	Key Lock capability to avoid unauthorized access to all test parameters. Memory Lock capability to avoid unauthorized access to memory locations.
Verification System	Built-in software driven verification menu to test fault detection circuits.
Display	128 x 64 dot resolution with front panel contrast setting.
Alarm Volume Setting	Front panel adjustable volume setting with 10 set points.
Line Cord	Detachable 6 ft. (1.80m) power cable terminated in a three prong grounding plug.
Mechanical	Tilt up front feet. Dimensions: (W x H x D) 8.5 x 4.0 x 15.5 in. (216 x 103 x 390 mm) includes feet. Weight: 19.15 lbs. (8.7 Kgs)
Environmental	Operating Temperature: 32° - 104°F (0° - 40°C) Relative Humidity - 0 to 80%
Calibration	Traceable to National Institute of Standards and Technology (NIST). Calibration controlled by software. Adjustments are made through front panel keypad in a restricted access calibration mode. Calibration information stored in non-volatile memory.

3.2. Instrument Controls

3.2.1. Front Panel Controls

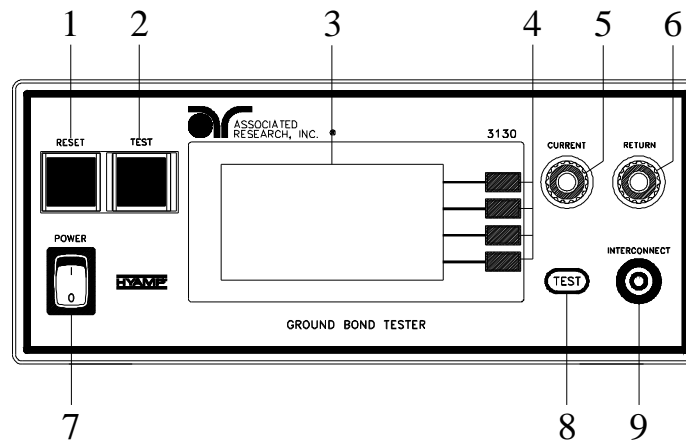

- 1. RESET BUTTON:** Momentary contact switch used to reset the instrument. If a failure condition occurs during a test, you will need to reset the system to shut off the alarm and signal the system that you are aware of a failure condition. The reset button must be pressed before you can proceed to the next test or change any of the set-up parameters. This switch also serves as an abort signal to stop any test in progress controlled by the HYAMP III.
- 2. TEST BUTTON:** Momentary contact switch used to start tests. Press the green button to activate the test that is set up in the test buffer shown on the display.
- 3. GRAPHIC LCD:** 128 X 64 Monographic LCD.
- 4. SOFT KEYS:** Multifunction parameter selection keys. Keys used to select screens and change parameters.
- 5. CURRENT OUTPUT JACK:** Connector used to attach the Current test lead, adapter box, or test fixture to the instrument.
- 6. RETURN OUTPUT JACK:** Connector used to attach the Return test lead, adapter box, or test fixture to the instrument.
- 7. POWER SWITCH:** Rocker style power switch with international ON (|) and OFF (0) markings.
- 8. TEST LED INDICATOR:** This red indicator flashes to warn the operator that voltage is present at the output terminal, and a test is in process.
- 9. INTERCONNECT JACK:** Connector used to attach the return lead from the hipot tester when performing both Hipot and Ground Bond tests on the same test item.

3.2.2. Rear Panel Controls

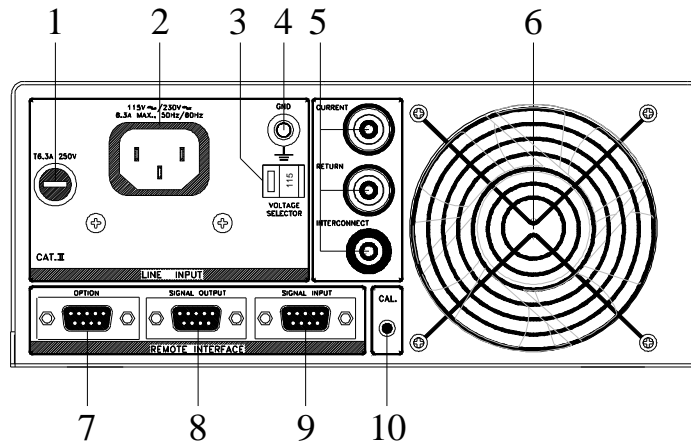

- 1. FUSE RECEPTACLE:** To change the fuse, unplug the power (mains) cord and turn the fuse receptacle counter-clockwise. The fuse compartment will be exposed. Please replace the fuse with one of the proper rating.
- 2. INPUT POWER RECEPTACLE:** Standard IEC 320 connector for connection to a standard NEMA style line power (mains) cord.
- 3. INPUT POWER SWITCH:** Line voltage selection is set by the position of the switch. In the left position it is set for 115 volt operation, in the right position it is set for 230 volt operation.
- 4. CHASSIS GROUND (EARTH) TERMINAL:** This terminal should be connected to a good earth ground before operation.
- 5. REAR PANEL OUTPUT CONNECTORS:** These connectors are in parallel with the front panel connectors.
- 6. THERMAL COOLING FAN:** Full time cooling fan.
- 7. OPTION CONNECTOR:** Undefined.
- 8. REMOTE SIGNAL OUTPUT:** 9-Pin D sub-miniature female connector for monitoring PASS, FAIL, PROCESSING, and RESET output relay signals.
- 9. REMOTE SIGNAL INPUT:** 9-Pin D subminiature male connector for remote control of test, reset, and interlock functions, as well as remote program memory selection and withstand processing input.
- 10. CALIBRATION BUTTON:** To put the instrument into the calibration mode, push this button and turn on the POWER switch simultaneously.

3.3. Quick start

This quick start guide assumes the operator has some familiarity with automated Ground Bond testing.

Locate a suitable testing area and be sure you have read all safety instructions for the operation of the instrument. Locate a three prong grounded outlet. Be sure the outlet has been tested for proper wiring before connecting the instrument to it.

CAUTION

Check to be sure that the correct input line voltage has been selected on the rear panel, either 115 volts AC or 230 volts AC. Connect the power-input plug into its socket on the rear panel of the instrument. Connect the male end of the plug to the outlet receptacle. Please be sure that the safety ground on the power line cord is not defeated and that you are connecting to a grounded power source.

Turn on the POWER switch located on the lower left-hand side of the front panel. The initialization screen will appear with a message at the bottom indicating <TEST> to verification. You now have the option to press the TEST button and activate the Verification Menu (Refer to the section **Instrument Verification**). The option to activate the Verification expires approximately 3 seconds after power-up. If you do not press the TEST button within the 3-second window, the initialization screen will disappear. The initialization screen will appear as follows:



After the initialization screen disappears, the Perform Tests screen will be displayed. The Perform Tests screen will appear as follows:

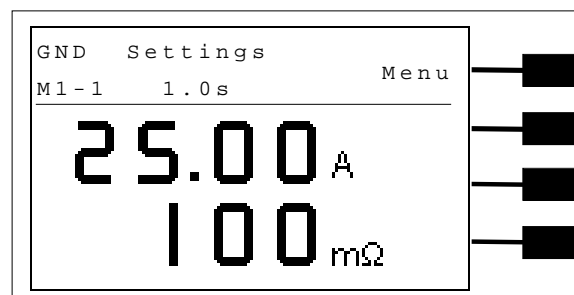

The HYAMP III comes with all of the memories and steps loaded with the default parameters. The initial test loaded for use is Memory 1, Step 1. If this test is unacceptable for your DUT then refer to the section **4.3 Setting Up a Test**, for instructions on how to program tests into the instrument.

If these parameters are acceptable then connect an appropriate set of test leads to the device under test (DUT) or test fixture. Make sure the safety ground of this instrument is connected to a known good ground.

WARNING

DO NOT TOUCH THE DEVICE UNDER TEST ONCE THE TEST HAS BEEN STARTED.

Remote Interlock

HYAMP III is equipped with a feature referred to as “Remote Interlock”. Remote Interlock is a feature that utilizes a set of closed contacts to enable the instruments output. In other words, if the Interlock contacts open, the output of the instrument will be disabled. Remote Interlock could also be referred to as a remote system lockout, utilizing “Fail When Open” logic. If the Interlock contacts are open and the Test button is pushed, a pop-up message will be displayed on the screen for two seconds. The message will appear as follows:

Interlock is Open

If the Interlock contacts are opened during a test, the pop-up message will be displayed and the test will abort. The hardware has been configured to provide the interlock connections on pins 4 and 5 of the Remote Interface, Signal Input port. The instrument can still be used without the external interlock device as long as the Interlock Connector (38075 provided with unit) is plugged into the Remote Interface, Signal Input port. If there is nothing connected to the Remote Interface, Signal Input port to provide a connection to the interlock, the instrument will not perform tests.

Please check your connections to be sure they are making good contact. Clear the area of any debris that may create a hazardous situation and ask any unnecessary personnel to leave the area. To initiate the test, press the GREEN test button on the front panel. This is a momentary button and does not need to be held in the pressed position during the test. The instrument will then initiate the test presently loaded (in this case Memory 1, Step 1) .

If the DUT passes the test, you will hear a short audible beep. If a failure occurs you will hear a long audible alarm and the red failure indicator will light up. If a failure occurs during the test, a continuous alarm will sound and the red indicator light in the Reset button will illuminate.

To stop the alarm you must press the illuminated RED button marked “RESET.” This will silence the alarm, clear the red fail light, and reset the instrument for the next test. The RESET button may also be used to quickly ABORT a test and cut off the power to the DUT.

When a test is being performed, a red test indicator located in the lower right side of the front panel will illuminate and flash until the test is finished. If the DUT passed the test, you will hear a brief beep indicating the DUT passed and that the tests are complete.

Reviewing results

The most direct method for reviewing test results is to press the bottom soft key at the end of the test. Pressing the bottom soft key from the Perform Test screen will display the Results screen. For more information about reviewing test results, refer to section **4.2.3 Reviewing Test Results**.

4. Programming Instructions

4.1. Setup System (Refer to FIG.1).

1. From the Perform Test screen, press the “Menu” soft key. The Main Menu will now be displayed.
2. From the Main Menu screen, press the “Menu” soft key. The Results, Tests and System selections will now be displayed.
3. From this screen, press the “System” soft key. The Setup System menu will now be displayed.
4. At the Setup System menu, scrolling from the PLC Remote parameter is restricted to down only. Press the down arrow key to access system parameters.
5. Scrolling to <More> will display the second page of System Parameters.

From the Setup System screen, fourteen different Hardware and Software controls may be accessed; PLC Remote, Single Step, Alarm, Contrast, Results, Lock, Mem Lock, Hipot Start, Cal Alert, Cal Date, Cal Due, Alert, Date and Time. Pressing the EXIT key at any time will return you to the Perform Test screen.

FIG.1

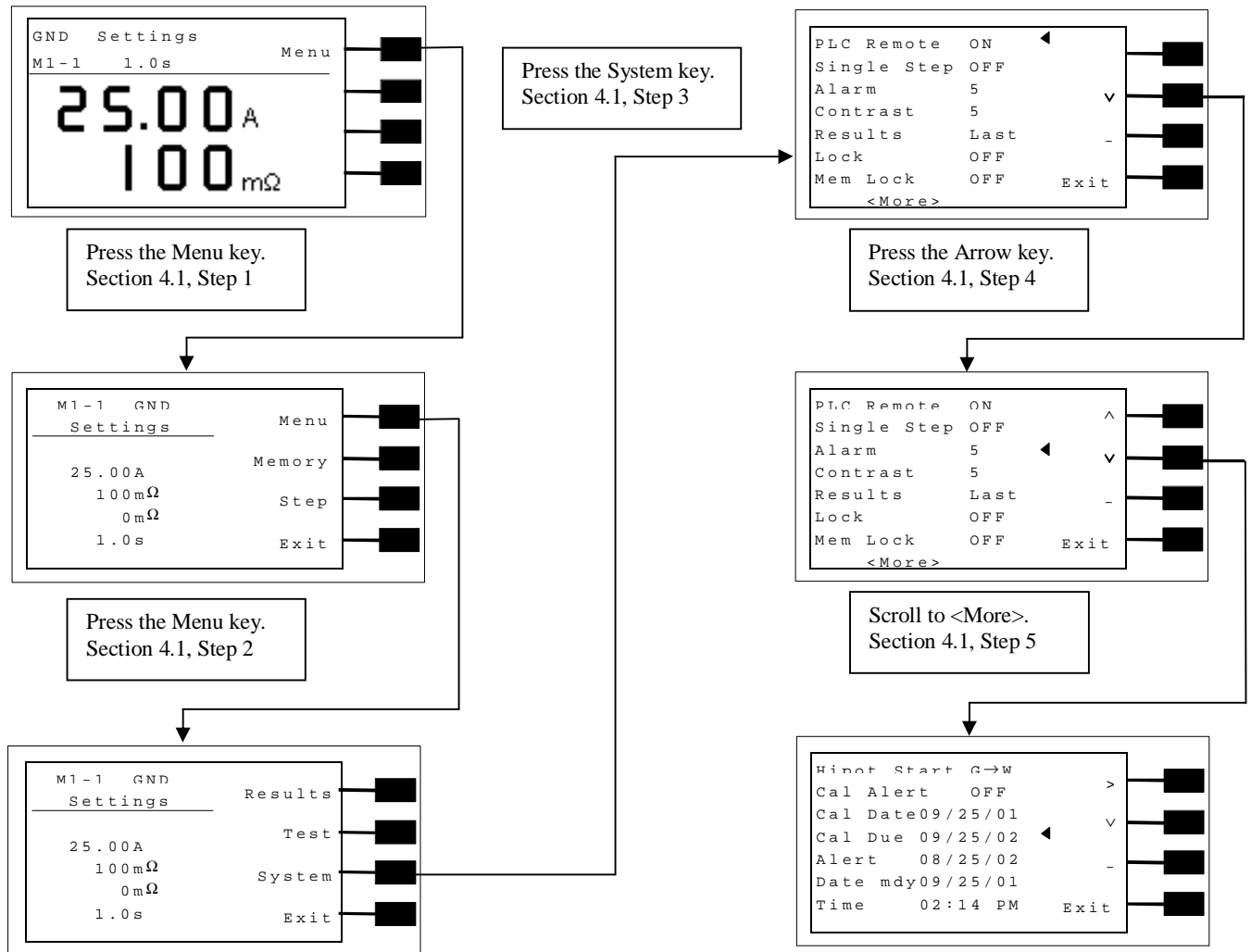

4.1.2. Setup System Soft keys

Directional soft keys >, ^, v

The “>, ^, v” soft keys are used to scroll the cursor to the different system parameters.

+

The “+” and soft key is used to increase or decrease numerical values or toggle settings ON and OFF.

Exit

The “Exit” soft key is used to return to the Perform Tests screen.

4.1.3. System Parameters

Directional soft keys, v (down), ^ (up), and > (right), are used to navigate the System parameters during reviewing and editing. The directional soft keys in the system parameters will change depending on which parameter the cursor is pointing to. At the PLC remote parameter, only the down arrow key is available.

PLC Remote

Scroll the cursor to the PLC Remote parameter using the directional soft keys. When the cursor is pointing to the PLC Remote parameter, you may turn the PLC remote function ON and OFF by pressing the “+” soft key. Refer to the section **6.Connection of Remote I/O** for details.

When the PLC remote is turned “ON”, the front panel Test button is disabled and a test may only be started through the rear panel I/O. If you attempt to start a test from the front panel Test button when the PLC Remote function is turned “ON”, a pop-up message will be displayed. The pop-up message will appear as follows:



PLC Remote ON

Single Step

Scroll the cursor to the Single Step parameter using the directional soft keys. When the cursor is pointing to the Single Step parameter, you may turn the function ON and OFF by pressing the “+” soft key.

This function is used to temporarily override the automatic connection feature. When the Single Step function is ON the instrument will pause after each step is completed. To continue the test sequence, press the Test button to execute the next connected step. Each time the Test button is pressed the next connected step will execute. If you press the Reset button before

completing all connected steps, it will return you to the original starting step. If a step fails and you wish to continue to the next step do not press Reset.

Alarm Volume

Scroll the cursor to the Alarm parameter using the directional soft keys. When the cursor is pointing to the Alarm parameter, you may use the “+” soft key to increase and decrease the volume of the Alarm.

The numbers corresponding to the different volume settings are 0 through 9, 0 meaning the volume is off and 9 being the loudest setting. After the “+” is pressed, a momentary alarm chirp will occur to indicate the volume of the new setting.

LCD Contrast

Scroll the cursor to the Contrast parameter using the directional soft keys. When the cursor is pointing to the Contrast parameter, you may use the “+” soft key to increase and decrease the contrast of the LCD display.

The numbers corresponding to the different contrast settings are 0 through 9, 0 meaning the lightest color of displayed characters and 9 meaning the darkest color of displayed characters. After the “+” is pressed, the display will automatically adjust to the new display setting.

Results

Scroll the cursor to the Results parameter using the directional soft keys. When the cursor is pointing to the Results parameter, you may use the “+” soft key to select what type of results you would preferred displayed at the end of a test or sequence of connected steps. The available selections are: All, P/F and Last.

When All is selected, a Results summary screen will be displayed at the end of the test or sequence of connected steps, displaying the results of all of the steps. The Results summary screen will appear as follows:

GND Pass	1.0 s	■
M1-1_25.00 A	3 mΩ	
-----		■
GND Pass	1.0 s	
M1-2_25.00 A	3 mΩ	■

GND Pass	1.0 s	■
M1-2_25.00 A	3 mΩ	

When P/F is selected, a Pass or Fail screen will be displayed at the end of the test. The Pass and Fail screens will appear as follows:

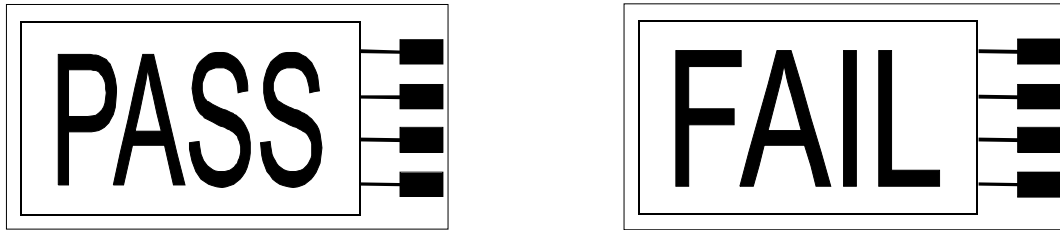

When P/F is selected, it is not possible to directly see the test results at the end of the test. In order to review the test results refer to section **4.2.3 Reviewing Test Results**.

When Last is selected, the results of the last step performed will be displayed on the Perform Tests screen. There will not be a change in appearance or special screen displayed in this mode.

Lock

Scroll the cursor to the Lock parameter using the directional soft keys. When the cursor is pointing to the Lock parameter, you may turn the function ON and OFF by pressing the “+” soft key. When the exit soft key is pressed, the security settings will take immediate effect.

Selecting Lock “ON” restricts access to parameter and system settings. The level of security is determined by the Mem Lock function.

Once the Lock function is activated, a special procedure is required to defeat the security. To defeat the security, press the top most soft key while powering up the instrument. Now you may access the system menu and turn the security function OFF.

Mem Lock

Scroll the cursor to the Mem Lock parameter using the directional soft keys. When the cursor is pointing to the Mem Lock parameter, you may turn the function ON and OFF by pressing the “+” soft key.

Mem Lock is a sub-function of the Lock setting. In order for the Mem Lock function to work, the Lock must first be turned “ON”. Selecting the Mem Lock “ON” will allow the user to access all available Memory locations and steps but restricts access to memory and step editing capabilities. Selecting the Mem Lock “OFF” will allow the user to only run the currently loaded memory.

Hipot Start

Scroll the cursor to the Hipot Start parameter using the directional soft keys. When the cursor is pointing to the Hipot Start parameter, you may toggle the selection between G→W and G + W by pressing the “+” and soft key.

The Hipot Start parameter is only used when connecting the HYAMP III with an Associated Research Hypot. The parameter controls if the Hypot will run after the HYAMP III has completed its test, G→W, or if the Hypot will run at the same time as the HYAMP III, G + W.

The Hipot Start parameter directly controls the Start output relay. G→W will momentarily close the start output relay at the end of the HYAMP III test and G + W will momentarily close the start output relay at the start of the HYAMP III test.

4.1.4. Cal Alert (Calibration Alert)

Calibration Alert is a feature that allows the instrument to give an advanced alert that the calibration for the instrument is coming due. Scroll the cursor to the Cal Alert parameter using the directional soft keys. When the cursor is pointing to the Cal Alert parameter, you may turn the function ON and OFF by pressing the “+” soft key.

Turning this parameter “ON” will activate the Cal Alert function and when the date matches the Alert Date, the instrument will display the Calibration Alert warning screen upon power up. If the “Show this screen again?” function has been turned “OFF” at the Calibration Alert Warning screen, this parameter will automatically be set to “OFF”.

Cal Date(Calibration Date)

Calibration Date is a non-editable parameter that indicates the Date when calibration was last performed on the instrument. This parameter automatically updates after calibrating the instrument.

Cal Due (Calibration Due Date)

It is recommended that calibration should be performed at least once a year. It is recommended that the Calibration Due date not be set greater than one year from the Calibration Date displayed. After a calibration is performed, the Calibration Due Date is automatically set 1 year after the calibration date.

This parameter defaults to one year after the calibration date but may be overwritten to any advanced date desired. Within the Calibration Due Date parameter are three separate fields, month, day, and year. Use the > key to select the field within the date you want to edit. Use the + key to change the numeric value. Once you change the value, it is automatically stored.

Alert (Alert Date)

The Alert date is like an alarm clock that will warn you in advance of the actual calibration due date. After a calibration is performed, the Alert Date is automatically set 11 months after the calibration date. For example, if the calibration is performed on 12/15/2002 the Alert Date will automatically be set to 11/15/2003.

This parameter defaults to 11 months after the calibration date but may be overwritten to any advanced date desired. Within the Alert Date parameter are three separate fields, month, day, and year. Use the > to select the field within the date you want to edit. Use the + key to change the numeric value. Once you change the value, it is automatically stored.

Date

Scroll the cursor to the Date parameter using the directional soft keys.

Within the Set Date parameter are four fields, date format (mdy / dmy), month, day, and year. Use the > key to select the field within the date you want to edit then use the + key to change the numeric value. Once you change the value, it is automatically stored.

Time

Scroll the cursor to the Time parameter using the directional soft keys.

Within the Set Time parameter are three fields, hours, minutes, and Military or Standard time setting. Use the > key to select the field within the time parameter you want to edit then use the + key to change the numeric value. Once you change the value, it is automatically stored.

The Calibration Alert Warning screen appears as follows:

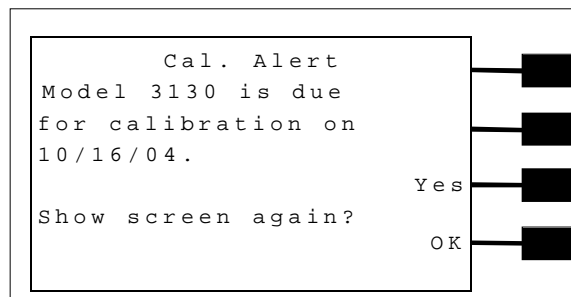

At the Calibration Alert Warning screen, there are two options, “Show screen again? Yes or No”. “Show screen again?” is asking if you would like to continue seeing the Calibration Alert Warning screen every time you power up the instrument. The question must be answered by toggling between the word “Yes” and “No” using its corresponding softkey and then pressing the OK softkey. You may turn this screen “OFF” by toggling to the word “No” using the soft key next to this parameter and pressing the OK soft key. Selecting the “Show this screen again” parameter “No” will disable the Calibration Alert function. You may leave this screen “ON” by toggling to the word “Yes” using the soft key next to this parameter and the pressing the OK soft key. Selecting the “Show this screen again” parameter “Yes” will exit the Calibration Alert Warning screen and go to the standard introduction screen without disabling the Calibration Alert function.

If security is enabled you will not see the question “Show screen again” or the Yes/No soft key.

It is possible to quickly bypass the security of the Calibration Alert by powering up the instrument while depressing the soft key that is second from the top of the instrument. This will temporarily start the instrument in an unsecured state. The Calibration Alert Warning screen will be displayed and allow you to disable the Calibration alert by selecting “No” and

then pressing the OK soft key. This type of security override only affects the Calibration alert screen. It is not necessary to restart the instrument to activate the security setting.

4.2. Setting up Tests (Refer to FIG.2).

4.2.1. Reviewing Test parameters

1. From the Perform Test screen, press the “Menu” soft key. The Main Menu will now be displayed.
2. Select the memory and step location you want to review or edit using their corresponding soft keys.
3. From the Main Menu screen, press the “Menu” soft key. The Results, Test and System selections will now be displayed.
4. From this screen, press the “Test” soft key. The Test parameter review screen will now be displayed. You may now review the test parameters by scrolling the cursor with the up and down arrow keys.

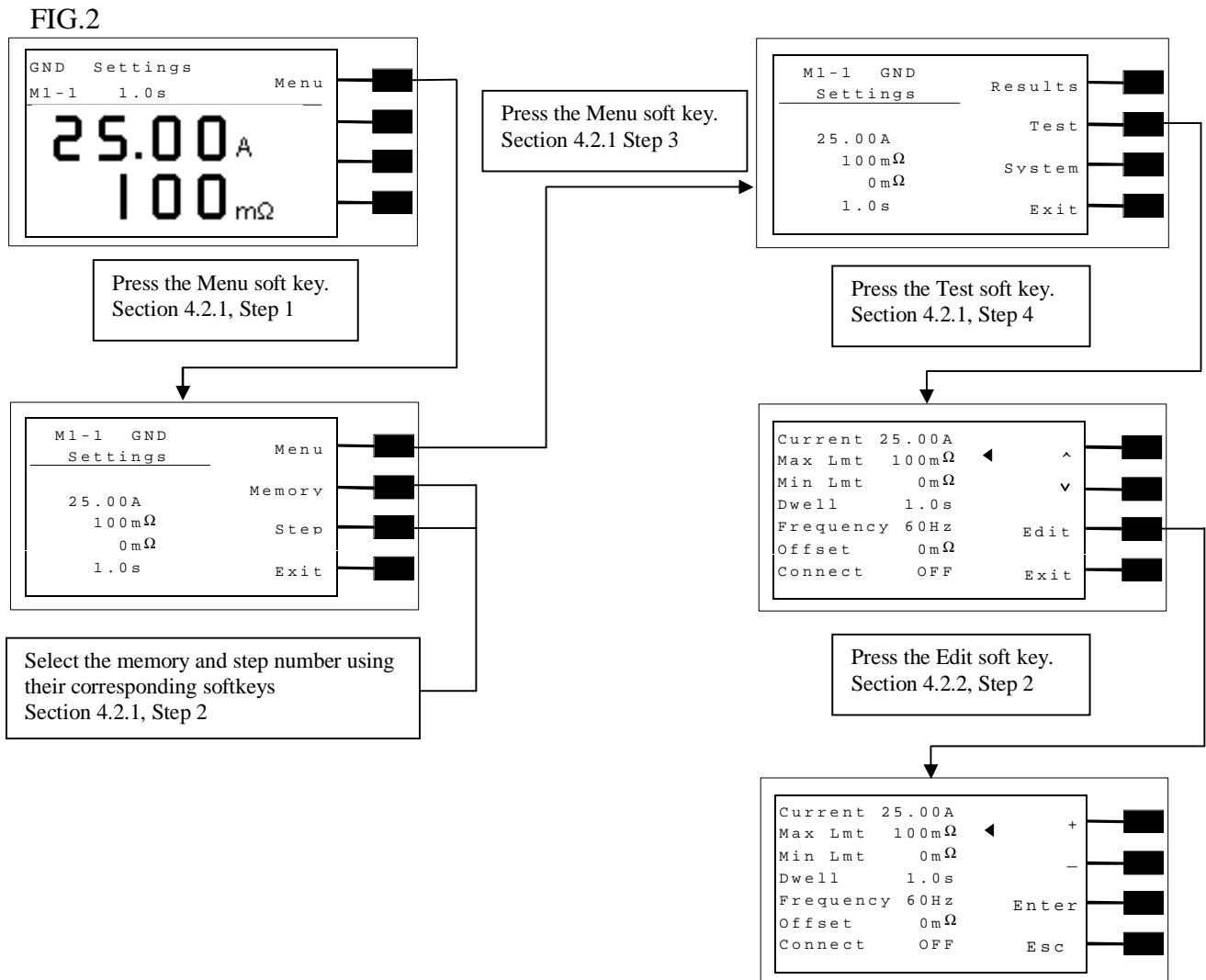

4.2.2. Editing Test Parameters (Refer to FIG.2)

1. From the Test parameter review screen (refer to section 4.2.1), scroll the cursor to the test parameter you wish to edit using the up and down arrow soft keys.
2. Press the “Edit” soft key. The Test parameter edit screen will now be displayed.
3. You may now change the value of the test parameter with the up and down arrow soft keys.
4. Press the “Enter” soft key to accept the new value or press “Esc” soft key to escape from the edit.

All available test parameters may be edited using this procedure.





4.2.3. Reviewing Test Results

Method 1, Hot key

1. Pressing the bottom soft key at the Perform Test screen will display the Results screen.

Method 2, Menu Selection

1. From the Perform Test screen, press the “Menu” soft key. The Main Menu will now be displayed.
2. From the Main Menu screen, press the “Menu” soft key. The Results, Test and System selections will now be displayed.
3. From this screen, press the “Result” soft key. The Results screen will now be displayed. The Results screen will appear as follows:

M1-1	GND		^	
Max-Fail			v	
Settings	Results			
25.00A	---A			
100mΩ	>120mΩ			
0mΩ	0.0s	Exit		
1.0s				

For connected tests, use the up and down soft keys to scroll through the results.

4.3. Test Parameters

Description of Test Parameters

Current: The Current that is applied between the Current and Return lead during a ground bond test.

Max-Limit: A maximum current or resistance threshold that when exceeded triggers a failure.

Min-Limit: A minimum current or resistance threshold that when not exceeded triggers a failure.

Dwell Time: A length of time that is allowed for the set point voltage to be applied.

Frequency: This parameter is selectable using a softkey between 50 and 60Hz.

Offset: This function allows the instrument to compensate for lead and test fixture resistance during a ground bond or continuity test. A description of how to set up this parameter is given in the **4.3.2 Ground Bond** parameter sections of this manual.

Connect: This function when turned ON will connect or link the current step to the next step. The third step in a Memory will not have this function because it is the last step of the Memory location.

4.3.2. Ground Bond Test Parameters

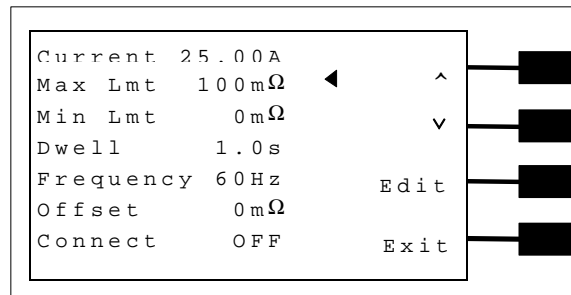

From the Ground Bond review screen the following parameters may be selected for editing, Current, Max-Limit, Min-Limit, Dwell, Frequency, Offset, and Connect.

Offset

The Offset function may be used to compensate for lead and test fixture resistance during the test. Using the up and down arrow keys, scroll the cursor to the Offset parameter and press the Edit softkey. You may now manually or automatically set an Offset value.

To manually set the Offset, use the “+” and “-” soft keys to increase and decrease the resistance value. Press the “Enter” soft key to accept the new value or press the “Esc” soft key to escape from the edit.

To automatically set an Offset value, set the current and frequency to the values that will be used on the DUT and connect the test cables or test fixture with fixturing to the instrument. Next, short circuit the ends of the test cables and press the “TEST” button. The instrument will now read the lead resistance and update Offset parameter automatically. Press the “Enter” soft key to accept the new value or press the “Esc” soft key to escape from the edit.

4.3.3. Default Parameters

The following table is a listing of the Default Parameters in the HYAMP III. These parameters may be programmed to all of the memories and steps by pressing the two bottom soft keys and powering the instrument at the same time. The Default Parameters are as follows:

Test Type	Parameter	Value
	Current	25.00A
	Max Lmt (current)	100mΩ
	Min Lmt (current)	0mΩ
	Dwell	1.0s
	Frequency	60Hz
	Offset	0mΩ
	Connect	OFF
Setup Sys.	PLC Remote	OFF
	Single Step	OFF
	Alarm	5
	Contrast	5
	Results	Last
	Lock	OFF
	Mem Lock	OFF
	Hipot Start	G→W
	Date Format	mdy (month, day, year)
	Cal Alert	ON
	Alert Date	Cal Date + 11 months

5. Operating Instructions

5.1. Instrument Connections

Test Leads

The test leads provided are designed specifically for use with this instrument. The red High Current lead will mate with the red Current jack. The black Return lead will install into the black Return jack.

The test lead ratings are as follows:

Description	Part Number	Rating
High Current lead	05002D-24	31 A, 750V
Return lead	05002D-37	31 A, 750V

Connecting the Test Leads

Connect the High Current lead (05002D-24, red markers) to the Current connector on the HYAMP III, then connect the other end of the lead to the earthing contact (usually the ground conductor connection point for the Line cord inlet).

Connect the Return lead (05002D-37) to the Return connector on the HYAMP III, then connect the other end of the lead to chassis ground

5.1.1. Adapter Box Connections(Adapter Box is sold separately)

The adapter box provides an easy way to connect a DUT to the HYAMP III that is terminated in a two or three-prong line cord. The following diagram shows how to connect the adapter box to the HYAMP III and to the device under test.

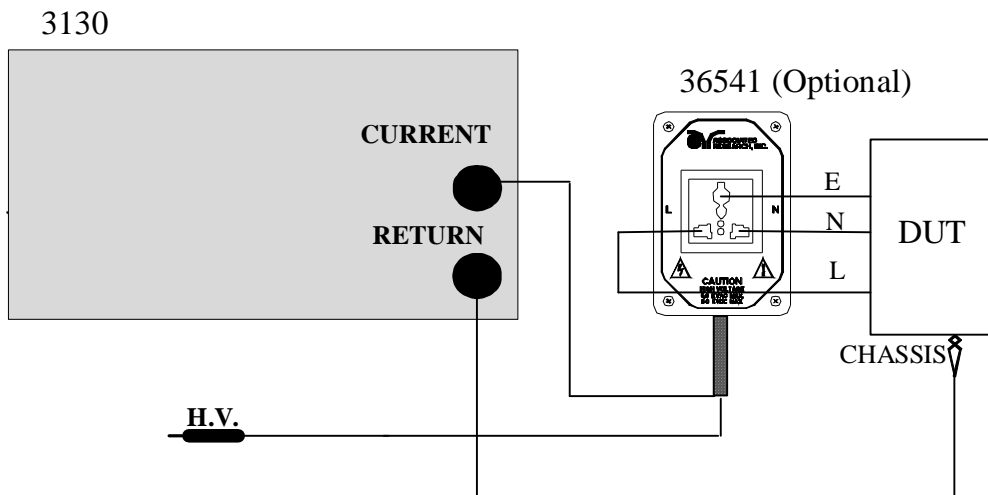

Test Connections

- The rear output connections on the HYAMP III may be used as well.

5.2. Perform Tests, Main Menu, and Results Screens

The HYAMP III automatically defaults to the Perform Tests screen upon power up. The Perform Tests screen will appear as follows:

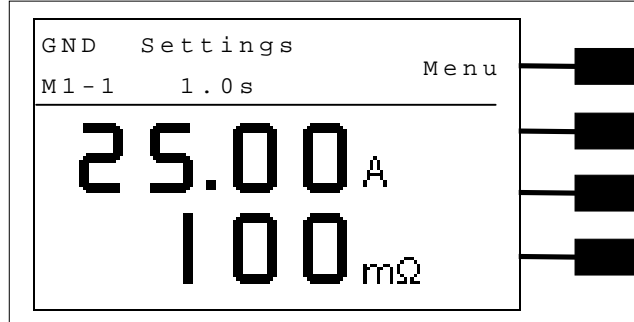

From the Perform Tests screen the Main Menu may be accessed by pressing the Menu softkey. The Perform Tests screen is the main operational screen of instrument. From this screen, test parameters are monitored while the test is being performed. This screen may also be used to debug memories with connected steps, with the use of the single step function.

5.2.1. Connected Step indicator

The connected step indicator is an under score symbol located directly next to the Memory and Step number and only will be displayed when the connect function has been turned "On" in the Test parameters.

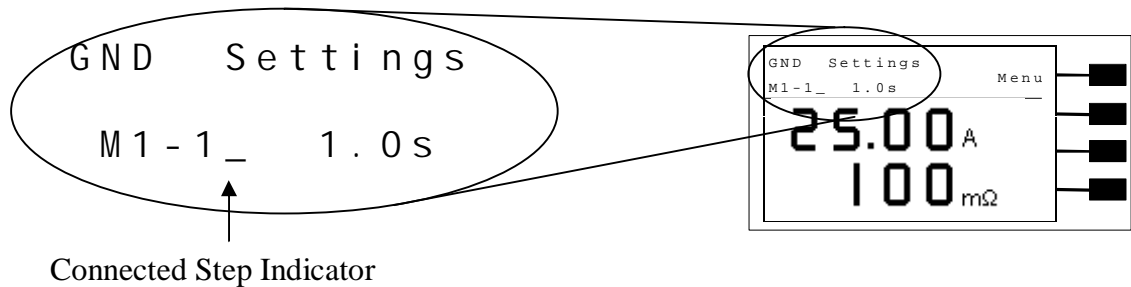

5.2.2. Main Menu

From the Perform Tests screen, press the "Menu" soft key.

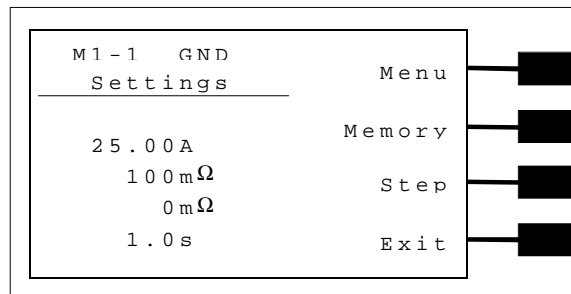

The Main Menu will now be displayed. From the Main Menu screen, three Software controls may be accessed, Menu, Memory, and Step. Pressing the “Exit” soft key at any time will return you to the Perform Tests.

Menu

Pressing the “Menu” soft key from the Main Menu will display the Results, Tests and System selections. Please refer to section **5.2.3 Results, Test, and System Menu**.

Memory

The HYAMP III has 10, three-step programmable memory locations (M0-M9). Press the “Memory” soft key to increment the instrument to the desired memory location. As the Memory softkey is pressed, the parameters of the selected memory location are automatically loaded into the instrument.

Step

Each of the ten memory locations in HYAMP III has three programmable steps that may be “Connected” together to create multi-step testing. Press the “Step” soft key to increment the step number.

5.2.3. Results, Tests and System Selections

From the Main Menu, press the “Menu” soft key.

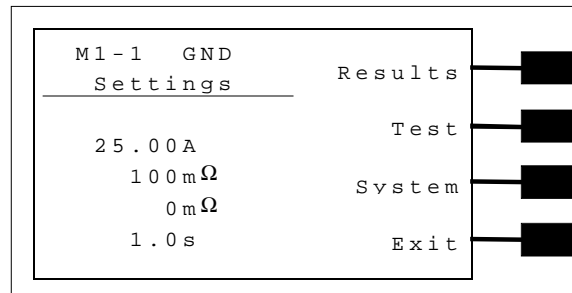

The Results, Tests and System selections will now be displayed. From the Results, Tests and System selection screen, three Software controls may be accessed; Results, Test, and System. Pressing the “Exit” soft key at any time will return you to the Perform Tests.

Results

Pressing the “Results” soft key from this menu will allow you to review the test results of the last test performed. An example of a Results screen is shown below.

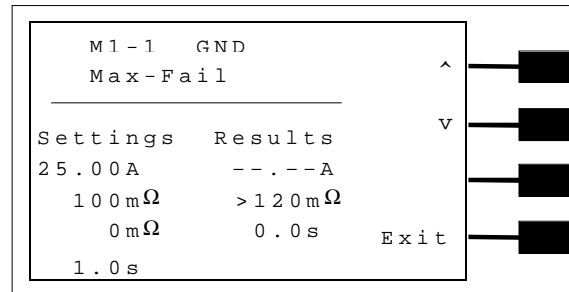

Test

Pressing the “Test” soft key from this menu will allow you to access the Parameter Review screen. For specific instructions for reviewing and editing test parameters, refer to section **4.2 Test Parameters**.

System

Pressing the “System” soft key from this menu will allow you to access the Setup System screen. For specific instructions for editing system parameters, refer to section **4.1 Setup System**.

5.3. Perform Tests Metering

The HYAMP III Perform Test screen will display Current, Time, and Resistance during a test.

5.4. Performing a Test

1. From the Main Menu, select the memory and step you wish to perform then press the “Exit” soft key to return you to the Perform Test screen.
2. Attach the appropriate load or DUT to the instrument (refer to section 5.1 for instrument connections).
3. Press the TEST button.
4. The instrument will now perform the test or connected sequence of tests. If the Test is started from any other step than 01, when you push Reset or Test buttons, it will always return to the originally selected step.

5.4.1. Single Step

Single step is a function that allows you to run one step at a time from a sequence of connected steps. To access the Single step function, refer to section **4.1 Setup System**. This function is used to temporarily override the automatic connection feature. When the Single Step function is ON the instrument will pause after each step is completed. To continue the test sequence, press the Test button to execute the next connected step. Each time the Test button is pressed the next connected step will execute. If you press the Reset button before completing all connected steps, it will return you to the original starting step. If a step fails and you wish to continue to the next step do not press Reset.

5.4.2. Description of displayed messages.

While performing tests, a number of messages will be displayed to indicate the test state or test results. These messages are displayed in the status area of the screen, located on the first line at the top of the LCD. These messages also used on other screens where test results are displayed.

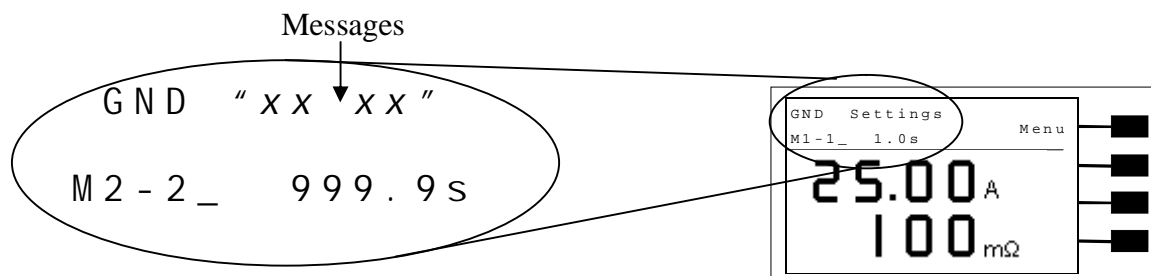

Dwell: This message appears on the display during the AC/DC Withstand test in process, when the values are being updated in real time.

Pass: This message appears on the display, when the test process is complete and the DUT passed the test.

Abort: This message appears on the display, if the test in process is aborted with the RESET button or remote Reset control.

Max-Fail: This message appears on the display, if the measured reading exceeds the Max Lmt current setting of the AC/DC Withstand test, or Max Lmt resistance setting of the Insulation Resistance test.

Min-Fail: This message appears on the display, if the measured reading drops below the Min Lmt current setting of the AC/DC Withstand test, or Min Lmt resistance setting of the Insulation Resistance test.

Short: This message appears on the display, if the DUT current is well beyond the metering range of the test.

Out-Error: This message appears on the display, after exiting from the Output Error screen. If the instrument has an internal problem and the TEST button is pressed, the Output Error screen will appear as follows:

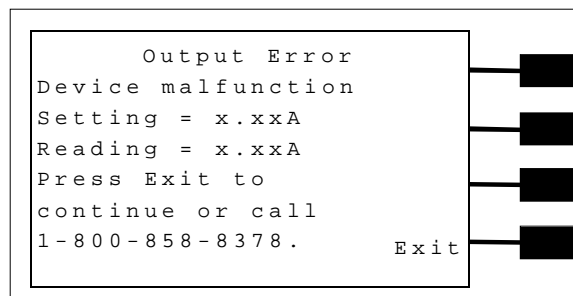

The RESET button is not active while this screen is displayed. To clear this screen and return to test mode the Exit soft key must be pressed. When the Exit soft key is pressed the instrument will continue with its normal failure indication process. The failure light and Alarm can then be cleared by pressing the RESET button.

6. Instrument Verification

Verification is a process by which an instruments fail detectors are proven to be functioning properly and thereby “Verifying” the functionality of the electrical safety tester and connected accessories. Verification of failure detect circuitry of the electrical safety tester is required by safety agencies such as CSA, UL, and TÜV.

6.1. Verification Initialization

Turn on the POWER switch located on the lower left-hand side of the front panel. The initialization screen will appear with a message at the bottom indicating <TEST> to verification. You now have the option to press the TEST button and activate the Verification Menu. The option to activate the Verification expires approximately 3 seconds after power-up. The Initialization screen will appear as follows:



6.2. Verification Menu

From the Initialization screen (First start up screen), press the TEST button. The Verification Menu will now be displayed.

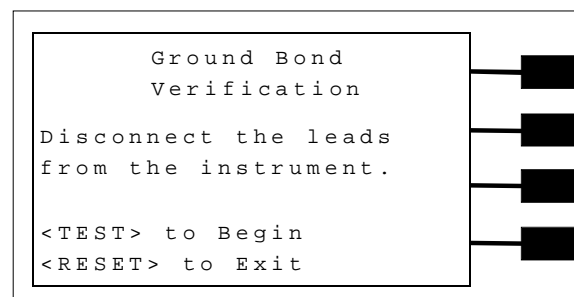

During the Verification process, all Remote control output signals, except the Fail output, are disabled.

6.2.1. Ground Bond Verification

From the Verification menu, press the TEST button to begin the verification process.

At the end of the Verification process, a message will appear indicating the outcome of the process. If the instrument passes the Verification (test failure, indicating the fail detectors are working properly) the RESET button will illuminate, the alarm will sound and the following message will appear:

```
GND                                0.0s
M1-1  0.01A                       >120mΩ
Verification OK
Ground Bond failure
detected.

<RESET> to Exit
```

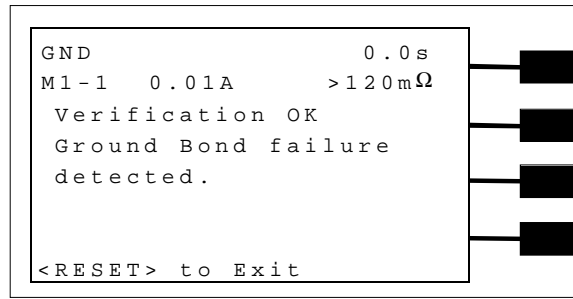

If the instrument fails the Verification (test pass, indicating the fail detectors are not working properly) the following message will appear:

```
GND                                1.0s
M1-1  29.99A                       2mΩ
Ground Bond failure
not detected. Check
leads or call.
1-800-858-8378
<TEST> to Retest
<RESET> to Exit
```

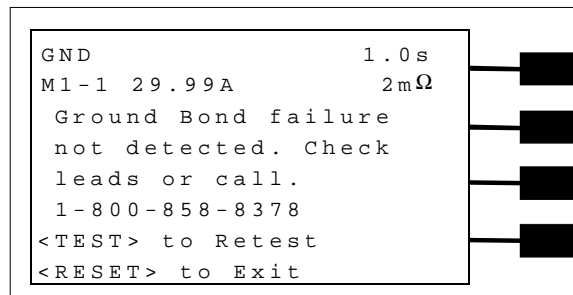

7. Connection of Remote I/O

Two 9-pin “D” type connectors are mounted on the rear panel that provide REMOTE-INPUT-OUTPUT control and information. These connectors mate with standard 9 pin D-sub-miniature connector provided by the user. The output mates to a male (plug) connector while the input mates to a female (receptacle) connector. For best performance, a shielded cable should be used. To avoid ground loops the shield should not be grounded at both ends of the cable. Suggested AMP part numbers for interconnecting to the Remote I/O are shown below:

205204-4	PLUG SHELL WITH GROUND INDENTS
205203-3	RECEPTACLE SHELL
745254-7	CRIMP SNAP-IN PIN CONTACT (for plug)
745253-7	CRIMP SNAP-IN SOCKET CONTACT (for receptacle)
745171-1	SHIELDED CABLE CLAMP (for either plug or receptacle)
747784-3	JACKSCREW SET (2)

Remote Interface Rear Panel

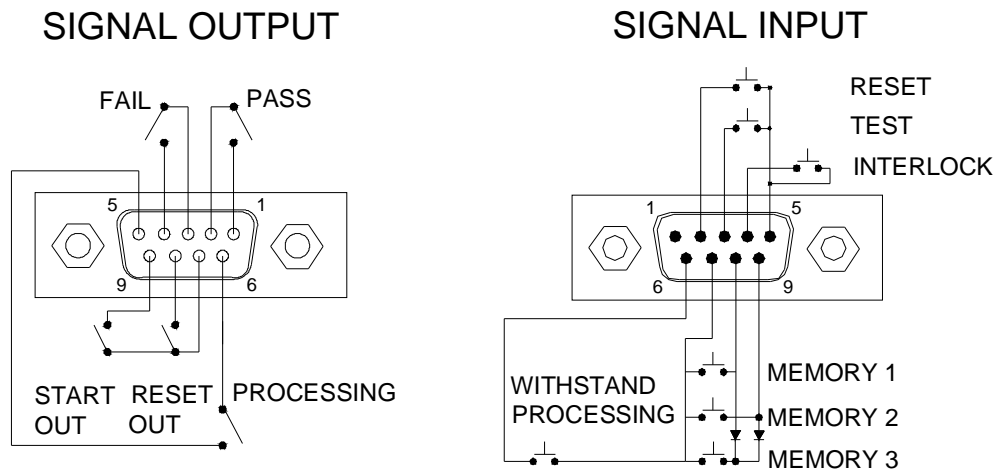

7.1. Signal Outputs on Remote I/O

The rear panel connector provides three output signals to remotely monitor PASS, FAIL, and PROCESSING conditions, and it also provides a RESET OUT pulse signal and a START OUT pulse signal. The monitoring signals are provided by three normally open internal relays that switch on to indicate the current condition of the tester. The RESET OUT signal and the START OUT pulse signal are also provided by a normally open internal relay. The RESET OUT gives a signal whenever the reset function is activated. This can be used to abort a withstand test while the units are interfaced as a test system. The START OUT gives a momentary output pulse that can be used to start the hipot test. These are normally open free contacts and will not provide any voltage or current. The ratings of the contacts are 1 AAC / 125 VAC (0.5 ADC / 30 VDC). The signal outputs

are provided on the 9 pin female type D connector. Below is a listing that indicates what conditions activate each pin. When a terminal becomes active the relay closes thereby allowing the external voltage to operate an external device.

Pins 1 and 2 provide the PASS signal.

Pins 3 and 4 provide the FAIL signal.

Pins 5 and 6 provide the PROCESSING signal.

Pins 7 and 8 provide the RESET OUT signal.

Pins 7 and 9 provide the START OUT pulse signal.

The following describes how the relays operate for each test condition.

PROCESSING - The relay contact closes the connection between pin (5) and pin (6) while the instrument is performing a test. The connection is opened at the end of the test.

PASS - The relay contact closes the connection between pin (1) and pin (2) after detecting that the item under test passed all tests. The connection is opened when the next test is initiated or the reset function is activated.

FAIL - The relay contact closes the connection between pin (3) and pin (4) after detecting that the item under test failed any test. The connection is opened when the next test is initiated or the reset function activated.

RESET OUT - The relay contact closes the connection between pin (7) and pin (8) while the reset function is activated. This is only a continuous closure dependent on the length of time the reset button is held in an active state.

START OUT - The relay contact closes the connection between pin (7) and pin (9). The Hipot Start parameter directly controls the Start output relay. $G \rightarrow W$ will momentarily close the start output relay at the end of the HYAMP III test and $G + W$ will momentarily close the start output relay at the start of the HYAMP III test.

The Hipot Start parameters main purpose is to control the sequential timing between HYAMP III and a connected Associated Research Hypot. The parameter controls if the Hypot will run after the HYAMP III has completed its test, $G \rightarrow W$, or if the Hypot will run at the same time as the HYAMP III, $G + W$.

7.2. Signal Inputs of Remote I/O and Memory Access

The HYAMP III remote connector enables remote operation of the TEST, RESET, REMOTE INTERLOCK, and WITHSTAND PROCESSING functions, and allows the operator to remotely select Memory 1, Memory 2, or Memory 3.

When the PLC Remote mode is on, the HYAMP III will respond to simple switch or relay contacts closures. A normally open momentary switch can be wired across pins 3 and 5 to allow remote operation of the TEST function. A normally open momentary switch can be wired across pins 2 and 5 to allow remote operation of the RESET function. When the PLC remote function is (ON) the TEST switch on the front panel will be disabled to prevent a test from being activated through this switch. For safety, the front panel RESET switch remains active even when a remote reset switch is connected so that high voltage can be shut down from either location.

The HYAMP III also allow access to three MEMORY PROGRAMS through the remote control connector. This gives the user the capability to quickly change parameters and initiate a test remotely. The HYAMP III basically operates in a PLC mode by responding to simple switch or relay contact closures. The built in memory programs of the instrument are used to accomplish this. Three internal memory programs can be accessed, by connecting terminals 7, 8, and 9 in different combinations.

WARNING

ACTIVATING MEMORY PROGRAM FUNCTIONS THROUGH THE REMOTE CONNECTOR, SELECTS THE PROGRAM AND STARTS THE TEST WHICH IS PREPROGRAMMED INTO THAT MEMORY

CAUTION

DO NOT CONNECT VOLTAGE OR CURRENT TO THE SIGNAL INPUTS, THIS COULD RESULT IN DAMAGE TO THE CONTROL CIRCUITRY.

MEMORY ONE - Momentarily connecting terminal 7 to 8 signals the instrument to immediately begin the test program that is stored in memory one.

MEMORY TWO - Momentarily connecting terminal 7 to 9 signals the instrument to immediately begin the test program that is stored in memory two.

MEMORY THREE - Momentarily connecting terminal 7 to terminals 8 and 9 signals the instrument to immediately begin the test program that is stored in memory three.

Remote Interlock

HYAMP III is equipped with a featured referred to as “Remote Interlock”. Remote Interlock is a feature that utilizes a set of closed contacts to enable the instruments output. In other words, if the Interlock contacts open, the output of the instrument will be disabled. Remote Interlock could also be referred to as a remote system lockout, utilizing “Fail When Open” logic. If the Interlock contacts are open and the Test button is pushed,

a pop-up message will be displayed on the screen for two seconds. The message will appear as follows:

Interlock is Open

If the Interlock contacts are opened during a test, the pop-up message will be displayed and the test will abort. The hardware has been configured to provide the interlock connections on pins 4 and 5 of the Remote Interface, Signal Input port. The instrument can still be used without the external interlock device as long as the Interlock Connector (38075 provided with unit) is plugged into the Remote Interface, Signal Input port. If there is nothing connected to the Remote Interface, Signal Input port to provide a connection to the interlock, the instrument will not perform tests.

Withstand Processing

When a HYAMP III is integrated with a Hipot as a test system, the processing signal from the hipot tester will be sent across pin (6) and pin (7) of the HYAMP III remote input. This signal will activate the front panel “Withstand Processing” indicator that notifies the operator that high voltage is enabled.

If the Hipot start is set to G→W (sequential) then the “Withstand Processing” indicator will appear as the following pop-up message:

**Withstand Test
is processing**

If the Hipot start signal is set to G+W then a small W-T indicator will appear in the upper right of the display.

PLC Remote Pop-up message

If you attempt to start a test from the front panel Test button and the PLC remote function is turned “ON”, a pop-up message will be displayed. The pop-up message will appear as follows:

PLC Remote ON

7.3. System 3100, HYAMP III Integrated with HYPOT III

The following illustration should be used to configure the HYAMP III for integrated operation with HYPOT III:

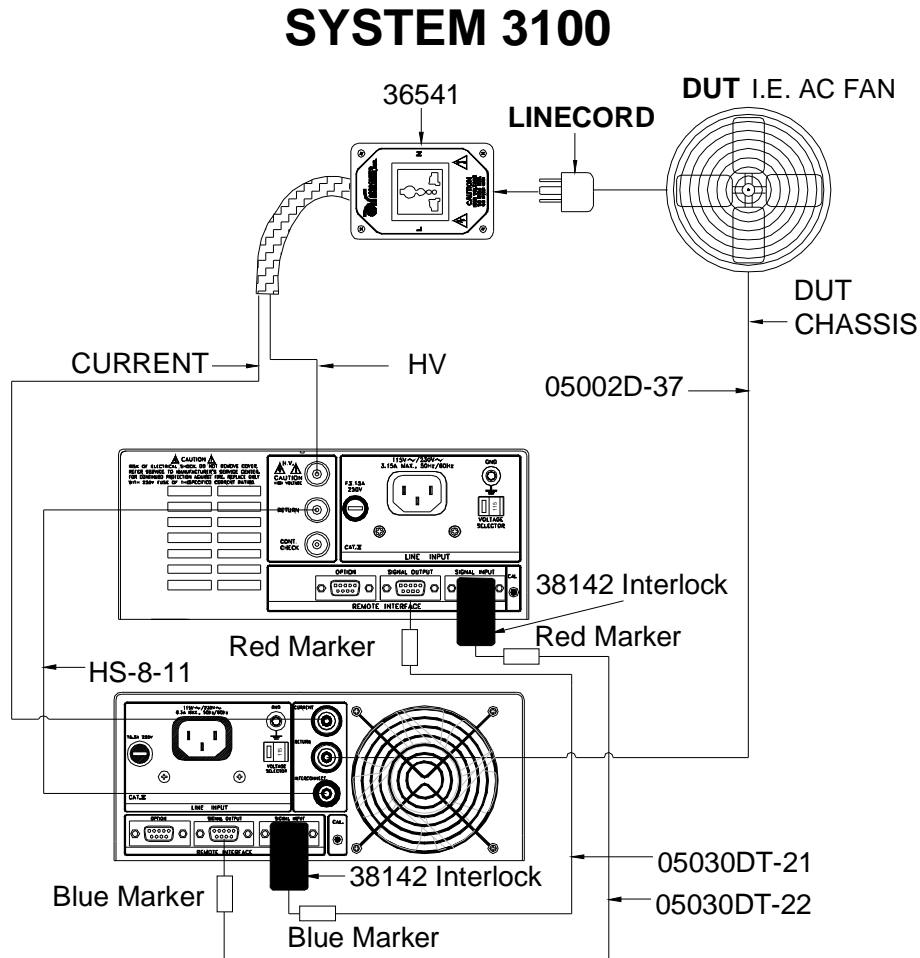

If you order the HYAMP III interconnect kit you will receive the following items.

Interconnect Kit		
Part Number	Description	Qty.
HS-8-11	Cable Assembly Return	1
5030DT-21	Cable Assembly R/P Interface COM	1
5030DT-22	Cable Assembly R/P Interface SEQ	1
38142	Interlock Connector	2
36541	Adapter Box HV, HC Domestic	1

When connecting HYAMP III to HYPOT III the 38075 Interlock connectors may no longer be used. The 38142 Interlock connectors provided with the kit will replace these parts.

When HYPOT III is connected to HYAMP III, the HYPOT III should have PLC remote turned on. In this configuration, you will only be able to start and reset the HYAMP III from the HYAMP III. It is possible to reset or abort the Hipot from both instruments.

7.3.1. Sequential and Simultaneous Testing

Hipot Start parameter

The Hipot start parameter, found in the system menu, controls whether the Hipot test will run sequentially after the Hyamp test or simultaneously with the Hyamp test. Please refer to section **4.1 Setup System** for instruction on how to set this parameter.

The Hipot Start parameter is only used when connecting the HYAMP III with an Associated Research Hypot. The parameter controls if the Hypot will run after the HYAMP III has completed its test, $G \rightarrow W$, or if the Hypot will run at the same time as the HYAMP III, $G + W$.

The Hipot Start parameter directly controls the Start output relay. Setting the Hipot start parameter to $G \rightarrow W$ will momentarily close the start output relay at the end of the HYAMP III test. Setting the Hipot start parameter to $G + W$ will momentarily close the start output relay at the start of the HYAMP III test.

8. Options

Introduction

This section contains a list and descriptions of available factory installed options at the time of this printing. The list of options contains an option code number that can be referenced on the data plate on the rear panel of the unit.

Option Label

On the rear panel of the instrument, you will find a label that contains the option code.

For example, your options code would appear as follows:

Fitted with option 04 OPT: 04
Fitted with option 01 and 04..... OPT: 0104

HYAMP III Options

Option List

Code	Description
02	Continuous Output with PASS Buzzer
04	PLC Ready Output
05	External RS-232 Converter

02 Continuous Output with PASS Buzzer

The Continuous Output with PASS buzzer option allows the user to perform multiple ground bond tests without the need to repeatedly energize and de-energize the output. All of the standard specifications for output ratings remain the same as the standard instrument. The operation of the failure judgment and indication are the fundamental differences in the operation of the instrument.

To make the best use of the continuous running feature the Dwell timer should be set to 0.0 seconds to enable the continuous running mode. However if the Dwell timer is set to any value other than 0.0 s, when the timer has completed the test results will be captured until the test is restarted.

To start the ground bond test the TEST button on the front panel can be pressed with the test leads connected or disconnected from the DUT. Once the test leads are connected to the DUT and the measured resistance is less than the Max-Limit setting and greater than the Min Limit setting, the instrument will indicate a PASS condition. A PASS condition is represented by an audible alarm and the illumination of the green PASS light on the front panel.

When the continuity is broken or the instruments measures a resistance value greater than the Max-Limit setting or lower than the Min-Limit setting, the red FAIL indicator will illuminate

and the alarm will turn off. The fail condition will remain until the resistance drops below the Max-Limit setting and above the Min-Limit setting, or until the Reset button is pressed to de-energize the output.

This operation emulates the basic audible continuity testers found on many multimeters, and is useful in doing multipoint ground bond tests on the DUT by disconnecting and reconnecting the test leads without disabling the output. This method is perfectly safe to the operator with regards to the voltage potential that is available on the test leads. The voltage potential between the leads is fixed at 6VAC.

04 PLC Ready Output

The PLC Ready Output Option creates a signal that acts as an instrument power-on indicator. The signal is available through the Remote I/O output connector which is located on the back of the instrument. This option closes the relay contact between pin (1) and pin (2) on the output connector once the instrument is powered on. The PLC Ready Output signal replaces the Pass signal that is present on the standard instrument.

It should be noted that the term “Ready” in “PLC Ready Output” only implies that the instrument is powered on. To perform a test, it should be verified that an interlock device is used or the interlock disable connector that was provided with the instrument is installed, and that there are no failure indicators active on the instrument. For more information on the Remote I/O signals/connections and interlock refer to Section 7, Connection of Remote I/O.

05 External RS-232 Converter

The External RS-232 Converter option will allow for remote bus communication with the HYAMP III. The following illustrations should be used to mount the RS-232 converter module to the case of the HYAMP III:

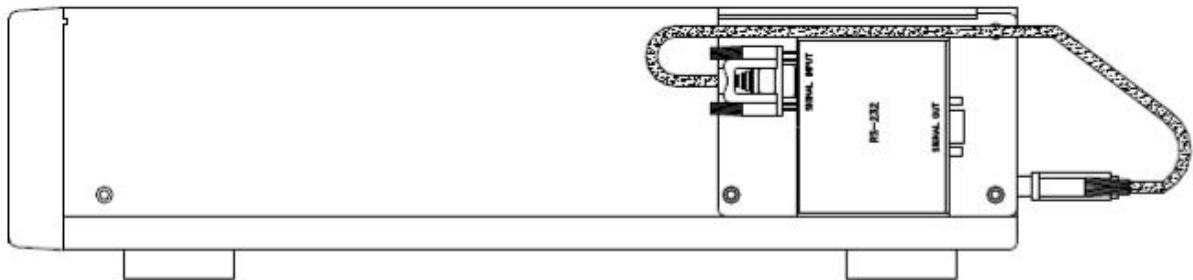

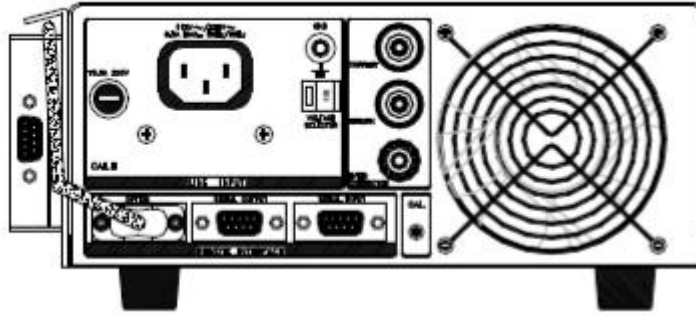

If you order the HYAMP III with External RS-232 Converter option you will receive the following items:

RS-232 External Module Part # 39050 includes:		
Part Number	Description	Qty.
39057	Cable 16 inch 9 Pin Male to 9 Pin Female Connector	1
38606	Cable Assembly RS-232 2 meter	1
37845	Screw M3 X 8mm FHMS Phillips	3

All instructions use the rear panel view as a reference point. The rear panel is shown above in the second illustration. The RS-232 external module is mounted to the left side of the HYAMP III. The following instructions detail the mounting of the panel.

Mount the RS-232 external module to the back left side of the HYAMP case using the three M3 X 8mm FHMS Phillips screws. The three screws currently in place there will need to be removed in order to mount the module. The SIGNAL INPUT port on the RS-232 external module should be facing the front of the HYAMP III and the SIGNAL OUT port should be facing the rear of the HYAMP III.

Connect the 16 inch 9 pin male to 9 pin female cable from the SIGNAL INPUT port on the RS-232 external module to the OPTION port on the rear of the HYAMP III. This connection will allow the HYAMP III to pass information to the RS-232 external module. Finally, connect the 2 meter RS-232 cable from the SIGNAL OUT port on the RS-232 external module to the appropriate PC. The unit is now set for remote bus communication.

RS-232 Interface

The RS-232 cabling for the connection from the SIGNAL OUT on the RS-232 external module to the PC should be configured as follows for a 9-pin serial port interface:

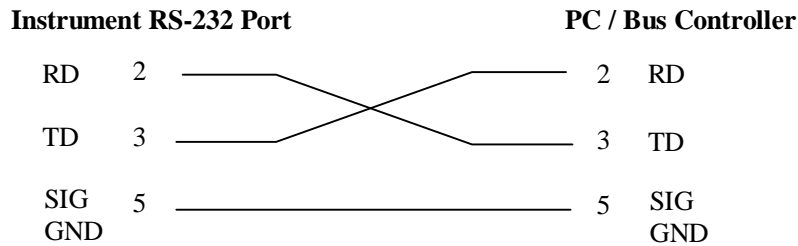

The COM port should have the following configuration. 19200 baud, 8 data bits, 1 stop bit, no parity. This interface does not support XON/XOFF protocol or any hardware handshaking. The controller should be configured to ignore the handshaking lines DTR (pin 4), DSR (pin 6), CTS (pin 8) and RTS (pin 7). If the port cannot be configured through software to ignore the lines then the handshake lines should be jumpered together in two different sets. Pins 4 and 6 jumpered together and pins 7 and 8 jumpered together at the controller end of the cable.

When sending command over the RS232 bus, the instrument will send a response string of 06 hex or 6 decimal, the Acknowledge (ACK) ASCII control code if the transfer was recognized and completed by the instrument. If there is an error with the command string that is sent, the instrument will respond with 15 hex or 21 decimal, the Not Acknowledge (NAK) ASCII control code. The ACK or NAK response allows for software handshaking, to monitor and control data flow. When requesting data from the instrument, it will automatically send the data back to the controller input buffer. The controller input buffer will accumulate data being sent from the instrument including the ACK and NAK response strings, until it has been read by the controller.

RS-232 Interface Command List

The RS-232 bus will automatically send any response back to the controller's input buffer. Note that the commands are case sensitive and must be typed in capital letters. Each command string should be terminated by the ASCII control code, New Line <NL>, or OAh.

The following conventions are used to describe the commands syntax for the HYAMP III. Braces ({ }) enclose each parameter for a command string. Triangle brackets (<>) indicate that you must substitute a value for the enclosed parameter. The Pipe (|) is used to separate different parameter options for a command. The command and the parameter data must be separated with a space. All commands that end with a question mark (?) are query commands.

Test Execution Commands

The following commands are used to control actual output voltage and current from the instrument. Please observe all safety precautions.

Command	Description
TEST	Execute a Test
RESET	Abort a Test in Process or Reset Failures
AOFF	Auto Set Offset

TEST

Starts the test sequence at the selected step loaded into memory (RAM).

RESET

Stop or abort a test. Also used to reset a latched failure condition.

AOFF

Set the offset for the ground bond test. The cables and any test fixture should be connected before executing the command. This command will perform an actual test and all safety precautions should be observed when using this command.

File Editing Commands

The following commands are used to create or modify Test Setup Files.

Command	Description	Value
MSS <memory number step number>	Memory Step Select	memory number = 1-10 step number 1-3
SALL<memory+step,p1,p2,p3...>	Add all Parameters of a Test	

MSS<memory number step number>

Load a file by memory and step number. The first digit is the memory number and the second digit is the step number. Example: MSS 11 = memory 1 step 1

SALL <memory+step, p1, p2, p3... >

This command edits all parameters in a memory and step. Parameters will be edited at the step location that has been selected. Example: SALL<11,10.00,100,0...>

The parameter <memory+step> indicated the memory and step number. The parameters <p1,p2> etc. indicate the individual settings for each test. All parameters must be included with the command and should appear in the same order that is shown in the table below. Also, like the individual parameter editing commands, the unit should not be included with the value. Only the numeric value should be included in the command string. The list of parameters can also be found in the default parameters section of the manual, or refer to the Test Parameter Editing commands section for the proper values. The parameter values should use complete text and not use the coded values that are associated with the individual parameter setting commands such as "ON" and "OFF" for toggle field.

	GND
1	Memory + Step
2	Current
3	Max Limit
4	Min Limit
5	Dwell
6	Frequency
7	Offset
8	Connect (ON/OFF)

Test Parameter Editing Commands

These commands are used to modify the test parameter within each step. These commands require a parameter value to be included with the command. The writing of the parameter requires that the unit not be included with the value, only the numeric value should be included with the command.

Command	Name	Value
CONN {1 0}	Connect ON/OFF	1=On, 0=Off
CURR <value>	Edit Current	1.00-30.00A
DDT <value>	Dwell Time	0, 0.5-999.9sec
MAXL <value>	Edit Max Limit	0-510mΩ
MINL <value>	Edit Min Limit	0-510mΩ
FREQ {50 60}	Edit Frequency	50 or 60Hz
COFF <value>	Offset	0-100mΩ

System Parameter Editing Commands and Companion Queries

These commands are used to modify the system parameters for the instrument. These commands require a parameter value to be included with the command.

Command	Name	Value
PLC {1 0}	PLC Remote ON/OFF	1=On, 0=Off
SSTP {1 0}	Single Step ON/OFF	1=On, 0=Off
ALAR <value>	Alarm Level	0-9, 0=Off, 9=High
CNTR <value>	Contrast Level	0-9, 9=High
RLT {L A P}	Result Setting	L=Last, A=All, P=P/F
HS {1 0}	Hipot Start	0=Gà W, 1=G+W

Query Commands

These query commands will retrieve data from the instrument. These commands include functions for retrieving test data, test results and remote hardware.

Command	Name	Value
TD?	List Testing Data	Data from test in Process
RD <step number>?	Result Data Query	1-3
SALL?	List Step Parameters	Response: SALL memory+step,p1,p2,p3...
RR?	Read Reset Query	1=Open, 0=Closed
RI?	Read Interlock Query	1=Open, 0=Closed

TD?

Read the active data being displayed on the LCD display while the test is in process. It will also read the last data taken when the test sequence has completed. Each parameter is separated by commas and includes step number, test status, and metering. The syntax for this command response is {memory - step, status, meter 1, meter 2, meter 3}.

For example: M1-1,Pass,25.00A,100mΩ,1.0s

RD <step number>?

Read the results for an individual step. The step number is the actual step number that has been saved within the file, not the order of which the steps were executed. For example if the test was executed starting from step 2 and ending with step 3 then the first step test results will be found in location 2 not in location 1. Each parameter is separated by commas and includes step number, test status, and metering. The syntax for this command response is {memory - step, status, meter 1, meter 2, meter 3}. For example: M1-1,Pass,25.00A,100mΩ,1.0s

SALL?

Lists all the step parameters for the step currently selected. Each parameter is separated by commas and includes memory with step number and parameter values. The syntax for this command response is SALL memory+step, current, max limit, min limit, dwell, offset, connect.

RR?

Read the remote Reset input signal. When the remote reset has be activated by closing the contacts the query will return a value of 0 to indicate the instrument is being Reset.

RI?

Read the remote Interlock input signal. When the remote Interlock has be activated by opening the contacts the query will return a value of 1 to indicate the instrument is in the Interlock state and will not be able to generate output voltage or current.

9. Calibration Procedure

This instrument has been fully calibrated at the factory in accordance to our published specifications. It has been calibrated with standards traceable to the National Institute Standards & Technology (NIST). You will find in this manual a copy of the "Certificate of Calibration". It is recommended that you have this instrument re-calibrated and a safety check done at least once per year. AR recommends you use "Calibration Standards" that are NIST traceable, or traceable to agencies recognized by NIST to keep this instrument within published specifications.

End user metrology standards or practices may vary. These metrology standards determine the measurement uncertainty ratio of the calibration standards being used. Calibration adjustments can only be made in the Calibration mode and calibration checks or verifications can only be made while operating in Test mode.

9.1. Warranty Requirements

AR offers a standard one-year manufacture's warranty. This warranty can be extended an additional four years provided that the instrument is returned each year to Associated Research, Inc. for it's annual calibration. In order to be eligible for the extended warranty instruments must be returned to Associated Research, Inc. for calibration service at least once every twelve months.

A return material authorization number (RMA) must be obtained from AR before returning this instrument for calibration. To obtain an RMA number or for information regarding our warranty please contact our Customer Support Representatives at 800-858-TEST.

Required Calibration Equipment

- 30 Amp AC Ammeter.
- 10 VAC Voltmeter.

9.2. Calibration Initialization

Press and hold the calibration key on the rear panel with a pen, pencil or small screwdriver while powering ON the HYAMP III. The HYAMP III enters the calibration mode after the power on sequence is complete. The Calibration screen will appear as follows:

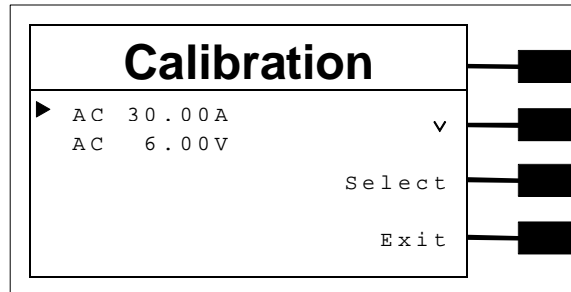

9.2.1. Calibration of Parameters





From the Calibration screens, use the “v” soft key to scroll the Cursor to the parameter you wish to calibrate. Once the cursor is pointing to the parameter you wish to calibrate, press the Select soft key. A calibration prompt screen will now appear that describes the necessary load and connection information for the parameter being calibrated.

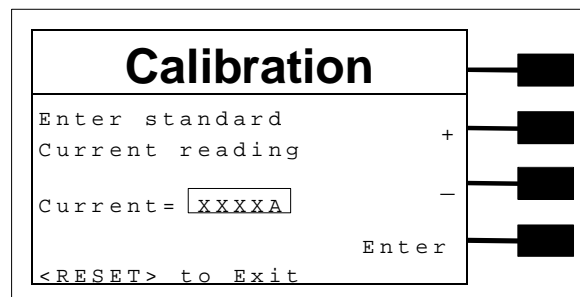
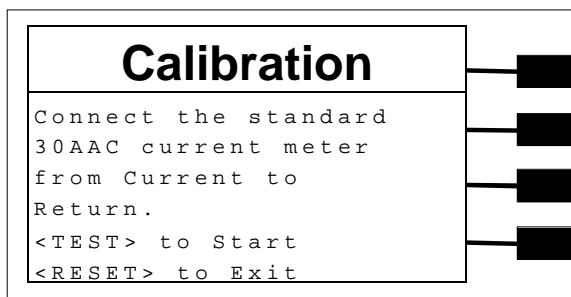



The following is a list of the calibration parameters and an example of the prompt screen with the details that will be displayed for each parameter (screen shown at left). Once you press TEST, the Calibration data entry screen will appear for the selected parameter (screen shown at right). Adjust the numeric value of the parameter using the “+” and “-” soft keys and press the “Enter” soft key to accept the new parameter or press RESET to escape the edit.



Calibration of Ground Bond AC Current



Calibration of Ground Bond AC Voltage

Calibration	
Step 1: Short the Current and Return leads together. <TEST> to Start <RESET> to Exit	   

Calibration	
Step 2: Connect the standard 6VAC volt meter from Current to Return. <TEST> to Start <RESET> to Exit	   

Calibration	
Enter standard Voltage reading Voltage= <input type="text" value="XXXXV"/> <RESET> to Exit	+  -  Enter 

10. Replacement Parts List

Rev. C 03/19/09 ECO 5373

3130

Part Number	Qty.	Reference Designator	Description
Supplied Accessories			
37780	1	-	Fuse, 6.3 Amp slow-blow, 250VAC
36541	1	-	Adapter Box, Optional
38075	1	-	Interlock Connector
05002D-24	1	-	Cable ASSY High Current Output
05002D-37	1	-	Cable ASSY High Current Return
Panel Components			
35999	2	-	Black Banana Jacks
37239	4	-	High Current Connectors
37497	1	-	Reset Switch, Red
37555	1	-	Power Switch 2P 10A/250V
37571	1	-	Earth Connector
37605	1	Fail	Bulbs
37673	1	-	Test Switch, Green
38101	1	-	Feet Kit w/o Rubber Inserts
38102	4	-	Rubber Insert for Feet
38320	1	-	128 x 64 Graphic Display
ICs and PCB Assemblies			
38262	1	IC16	Microcontroller 78E516B PLCC
38367	1	CON 3670	Main Control Board
38325	1	AMP 3130	Power Amplifier Board
38331	1	KEY 3670	Keypad Board
38268	1	PWR 3670	Input Voltage Select PCB
39050	1	RS232	Kit RS232 External module
Internal Components			
38326	1	T1	Input Transformer

- For safety tester interconnect cables, refer to INSTRUMENT CONNECTIONS; section 7.3.

11. Schematic Index

Drawing Number	Description	Reference Designator	Pages
S03130	Wiring Diagram 3130	-	1
S38367	Main Control Board	CON 3670	3
S38325	Power Amplifier Board	AMP 3130	2
S38267	Keypad Board	KEY 3670	1
S38268	Input Voltage Select PCB	PWR 3670	1
S39013	RS232 Interface Board	RS232-1	1

Index

Adapter Box.....	20, 36, 48, 55
Alarm Parameter	27
Benefits.....	13
Calibration Procedure.....	52
Connected Steps.....	15, 26, 27, 37, 40, 53
Continuity Test.....	10, 34
Contrast.....	19, 25, 27, 35
Controls	18, 20, 25, 29, 38, 45, 49
DC Withstand.....	40, 41
Default Parameters	23, 35
Dielectric Withstand Test	7, 8
Discharge	9, 10
DUT.....	11, 12, 14, 23, 24, 34, 36, 40, 41
Dwell	14, 18, 34, 35, 40
Edit Parameters	29, 30, 32, 33, 34, 53
Features.....	7, 13
Frequency	8, 13, 18, 34, 35
Front Panel Controls.....	13, 20
Glossary	3
Hypot.....	3
Insulation Resistance.....	7, 10, 12, 13, 41
Interlock.....	14, 15, 19, 21, 23, 46, 47, 48, 55
LCD.....	13, 14, 20, 27, 40
Leakage.....	9, 10, 11, 12
Limits.....	41
Lockout.....	23, 46
Max Lmt	35, 41
Medical Restrictions.....	6
Memory	14, 19, 21, 23, 28, 32, 34, 37, 38, 40, 46
Menu.....	11, 13, 19, 22, 25, 28, 32, 33, 37, 38, 39, 40, 42, 43, 49
Min Lmt	35, 41
Offset.....	13
Operator.....	5, 6, 9, 13, 14, 16, 20, 22, 46, 47
Options.....	30, 50

Parameters	
System Parameters	25, 26, 39
Test Parameters	13, 19, 32, 33, 34, 37, 39
PLC.....	25, 26
Programming.....	25
Rear Panel Controls.....	21
Receptacle.....	16, 21, 22, 44
Regulation.....	13, 18
Remote.....	14, 19, 21, 23, 25, 26, 35, 41, 42, 44, 46, 47, 49
Remote Interlock.....	23, 46
Resistance	3, 5, 6, 10, 11, 12, 13, 33, 34, 40, 41
Reviewing Test Results	24, 28, 33
Safety.....	2, 4, 7, 16
Safety Symbols	2
Schematic.....	56
Schematic Index.....	56
Security.....	13, 19, 28, 30
Sequence	15, 26, 27, 40, 53
Service Interval	4
Setup.....	13, 14, 25, 26, 35, 39, 40, 49
Short	23, 34, 41
Single Step.....	25, 26, 35, 37, 40
Specifications	18
System Parameters	25, 26
Test Parameters	25, 26
Test Station	5
Trip Point	3
TUV.....	14
UL.....	7, 11, 14, 42
Unpacking.....	15
Verification	19, 22, 42, 43
Warranty	1, 4, 52